

Feature

- 30V,100A
 $R_{DS(ON)} < 4.2m\Omega @ V_{GS}=10V$ (TYP:3.3m Ω)
 $R_{DS(ON)} < 7.0m\Omega @ V_{GS}=4.5V$ (TYP:5.0m Ω)
- Advanced Trench Technology
- Lead free product is acquired
- Excellent $R_{DS(ON)}$ and Low Gate Charge
- $T_{jmax}=175^{\circ}C$
- AEC-Q101 qualified

Application

- PWM applications
- Load Switch
- Power management

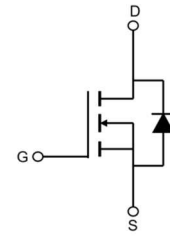

Schematic Diagram



Marking and pin assignment

Package Marking and Ordering Information

Device Marking	Device	Device Package	Reel Size	Tape width	Quantity (PCS)
30H100KA-AU	AP30H100KA-AU	TO-252	13 inch	-	2500

ABSOLUTE MAXIMUM RATINGS ($T_J=25^{\circ}C$ unless otherwise noted)

Parameter	Symbol	Value	Unit
Drain-Source Voltage	V_{DS}	30	V
Gate-Source Voltage	V_{GS}	± 20	V
Continuous Drain Current ($T_c=25^{\circ}C$)	I_D	100	A
Continuous Drain Current ($T_c=100^{\circ}C$)	I_D	54	A
Pulsed Drain Current ⁽¹⁾	I_{DM}	320	A
Single Pulsed Avalanche Energy ⁽²⁾	E_{AS}	306	mJ
Power Dissipation	P_D	83	W
Thermal Resistance from Junction to Case ⁽⁴⁾	$R_{\theta JC}$	1.8	$^{\circ}C/W$
Junction Temperature	T_J	175	$^{\circ}C$
Storage Temperature	T_{STG}	-55~ +175	$^{\circ}C$

MOSFET ELECTRICAL CHARACTERISTICS(T_J=25°C unless otherwise noted)

Parameter	Symbol	Test Condition	Min	Type	Max	Unit
Static Characteristics						
Drain-source breakdown voltage	V _{(BR)DSS}	V _{GS} = 0V, I _D =250μA	30	-	-	V
Zero gate voltage drain current	I _{DSS}	V _{DS} =30V, V _{GS} = 0V	-	-	1	μA
Gate-body leakage current	I _{GSS}	V _{GS} =±20V, V _{DS} = 0V	-	-	±100	nA
Gate threshold voltage ⁽³⁾	V _{GS(th)}	V _{DS} =V _{GS} , I _D =250μA	1	1.5	2.5	V
Drain-source on-resistance ⁽³⁾	R _{DS(on)}	V _{GS} =10V, I _D =30A	-	3.3	4.2	mΩ
		V _{GS} =4.5V, I _D =20A	-	5.0	7.0	
Dynamic characteristics						
Input Capacitance	C _{iss}	V _{DS} =15V, V _{GS} =0V, f =1MHz	-	2016	-	pF
Output Capacitance	C _{oss}		-	250	-	
Reverse Transfer Capacitance	C _{rss}		-	230	-	
Switching characteristics						
Turn-on delay time	t _{d(on)}	V _{DD} =10V, I _D =30A, V _{GS} =10V, R _G =3Ω	-	20	-	ns
Turn-on rise time	t _r		-	15	-	
Turn-off delay time	t _{d(off)}		-	60	-	
Turn-off fall time	t _f		-	10	-	
Total Gate Charge	Q _g	V _{DS} =10V, I _D =30A, V _{GS} =10V	-	60.5	-	nC
Gate-Source Charge	Q _{gs}		-	8.1	-	
Gate-Drain Charge	Q _{gd}		-	7.8	-	
Source-Drain Diode characteristics						
Diode Forward voltage ⁽³⁾	V _{DS}	V _{GS} =0V, I _S =1A	-	-	1.2	V
Diode Forward current ⁽⁴⁾	I _S		-	-	100	A

Notes:

1. Repetitive Rating: pulse width limited by maximum junction temperature
2. EAS Condition: T_J=25°C, V_{DD}=25V, R_G=25 Ω, L=0.5mH
3. Pulse Test: pulse width≤300μs, duty cycle≤2%
4. Surface Mounted on FR4 Board, t≤10 sec

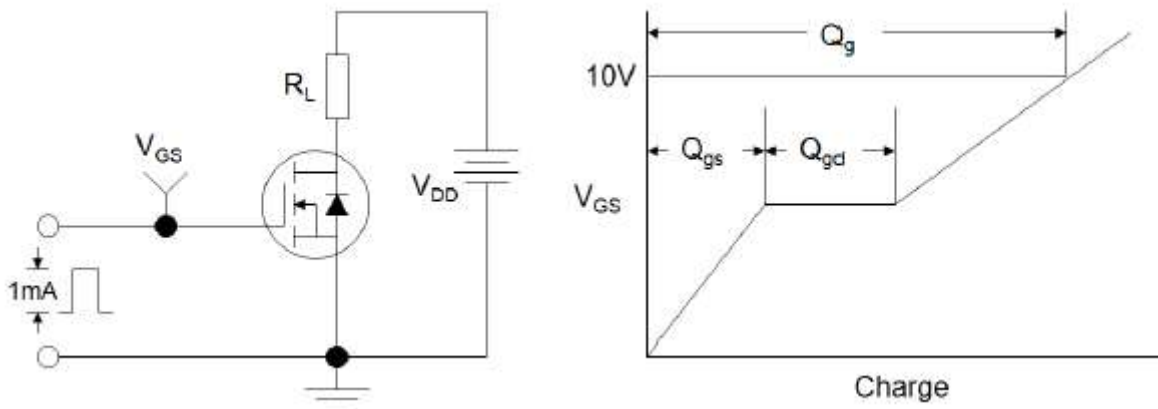

Figure1:Gate Charge Test Circuit & Waveform

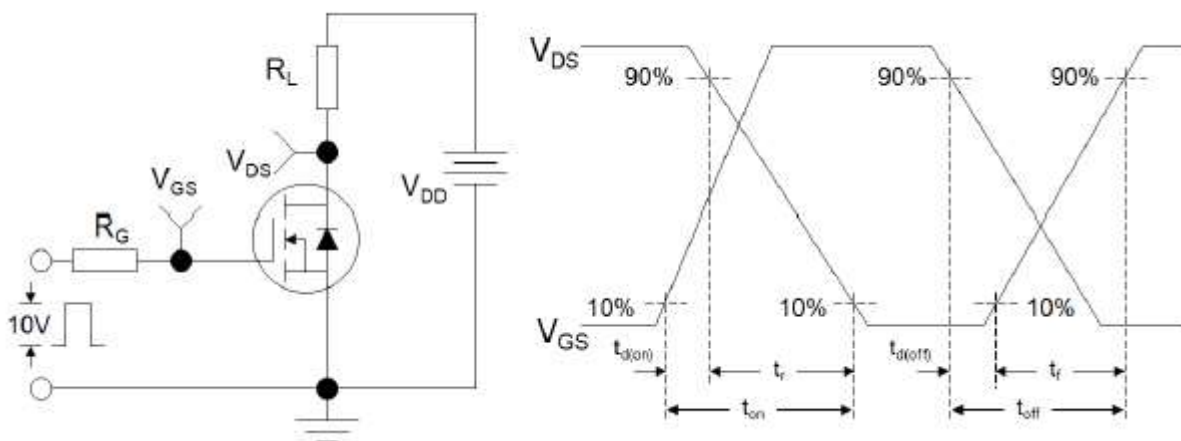

Figure 2: Resistive Switching Test Circuit & Waveforms

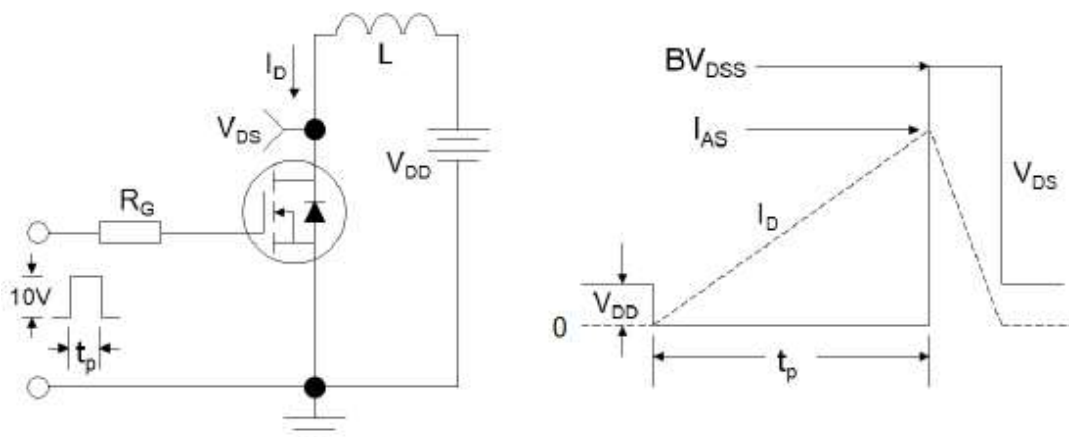

Figure 3:Unclamped Inductive Switching Test Circuit & Waveforms

Typical Electrical and Thermal Characteristics

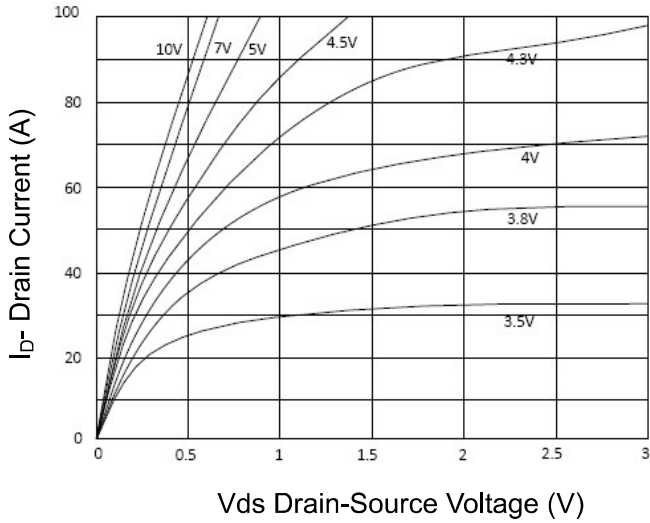

Figure 1 Output Characteristics

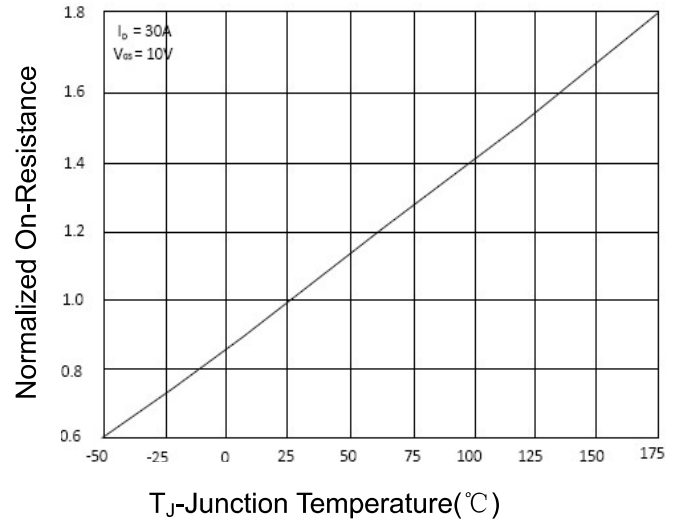

Figure 4 Rdson-Junction Temperature

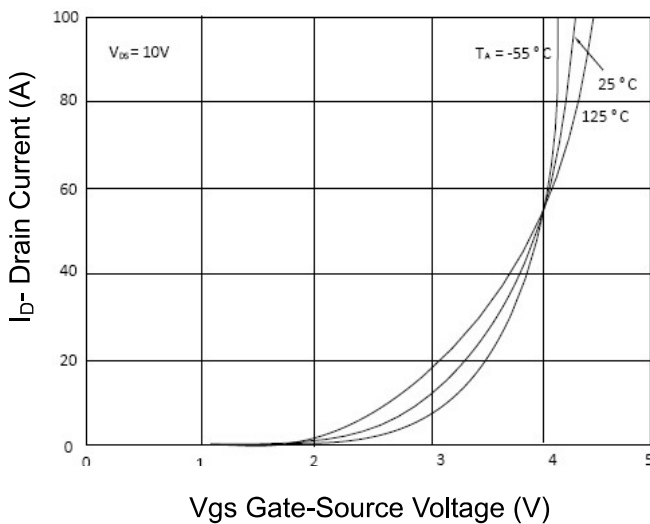

Figure 2 Transfer Characteristics

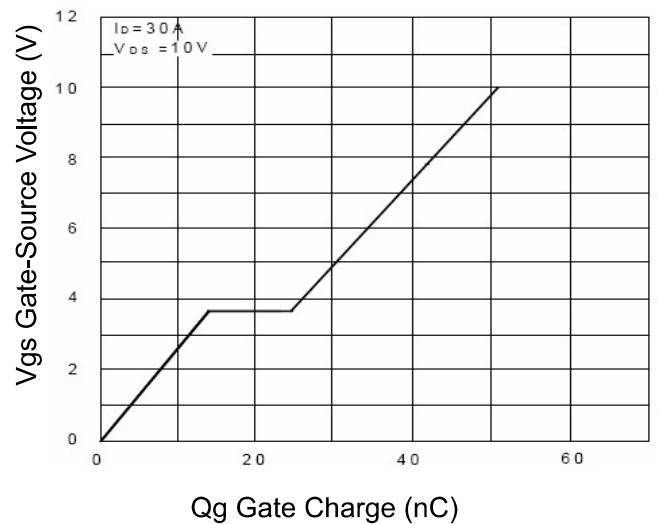

Figure 5 Gate Charge

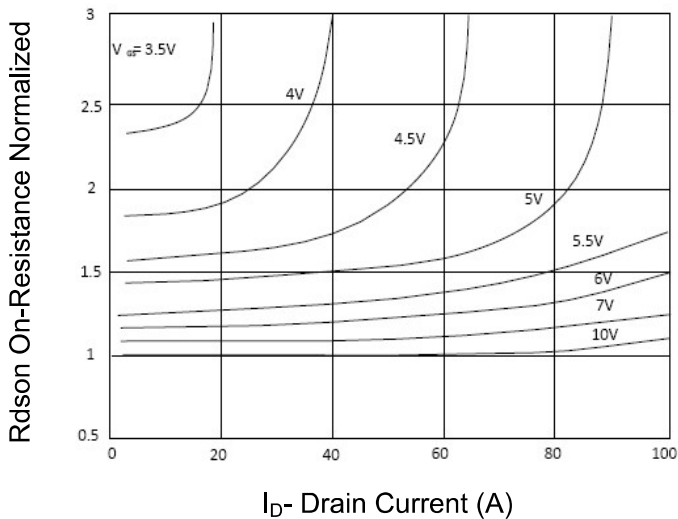

Figure 3 Rdson- Drain Current

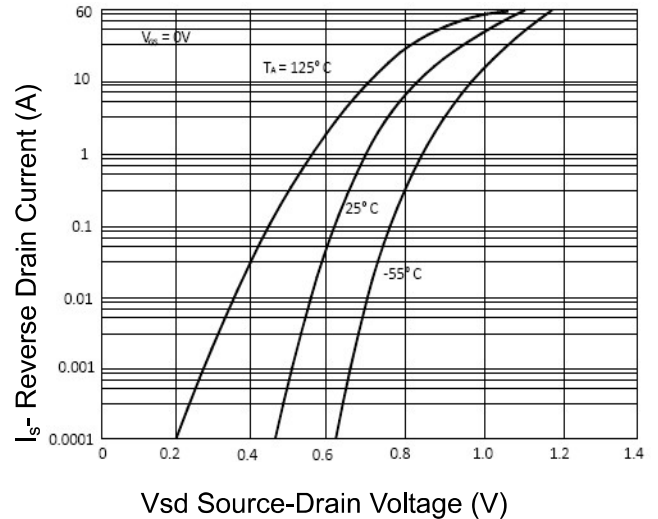

Figure 6 Source- Drain Diode Forward

AP30H100KA-AU

N-Channel Enhancement Mosfet

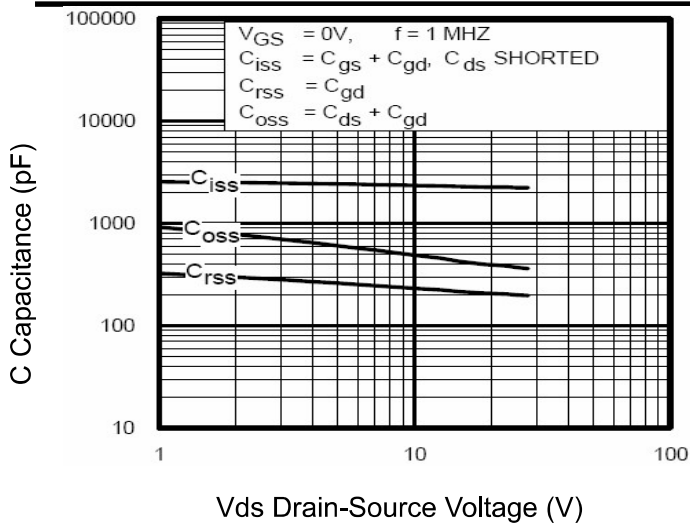

Figure 7 Capacitance vs Vds

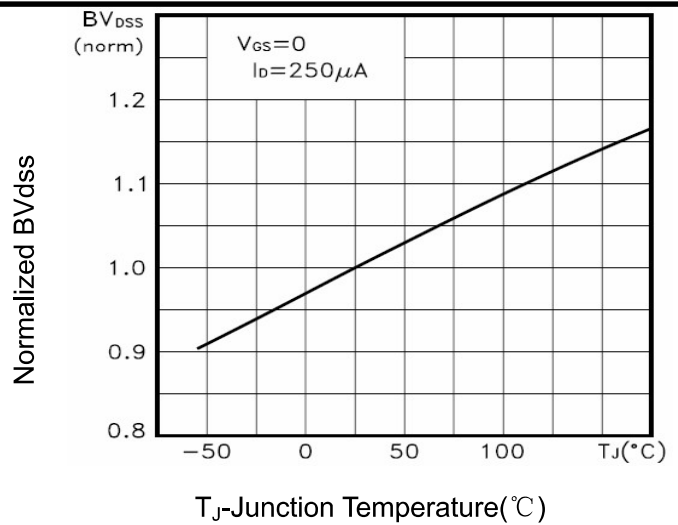

Figure 9 BV_{DSS} vs Junction Temperature

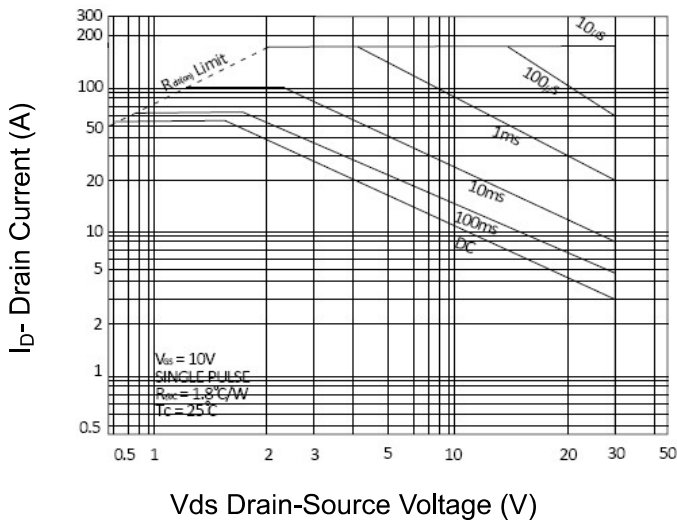

Figure 8 Safe Operation Area

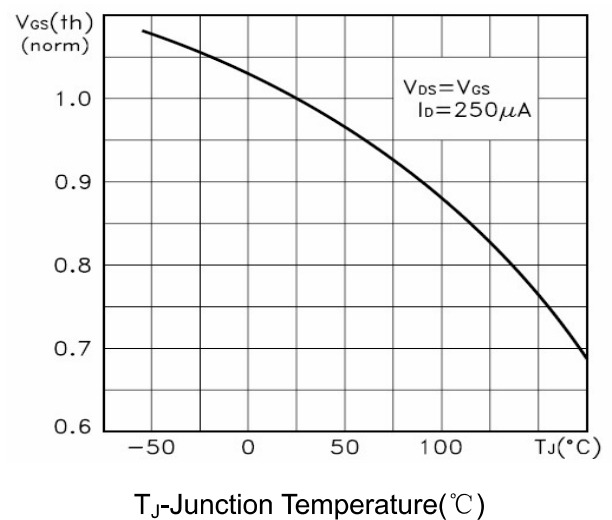

Figure 10 $V_{GS(th)}$ vs Junction Temperature

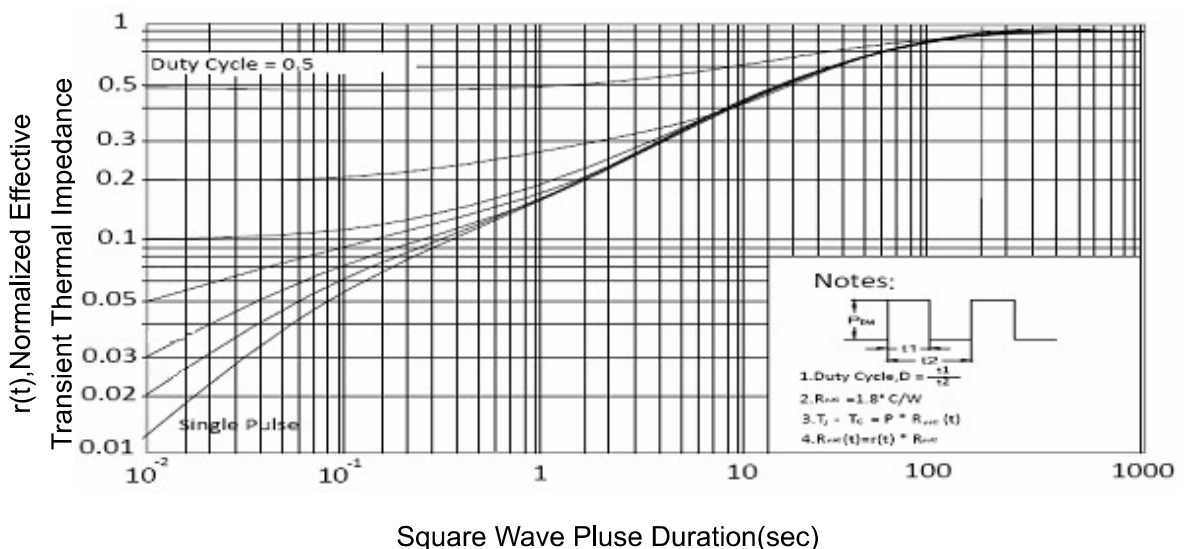
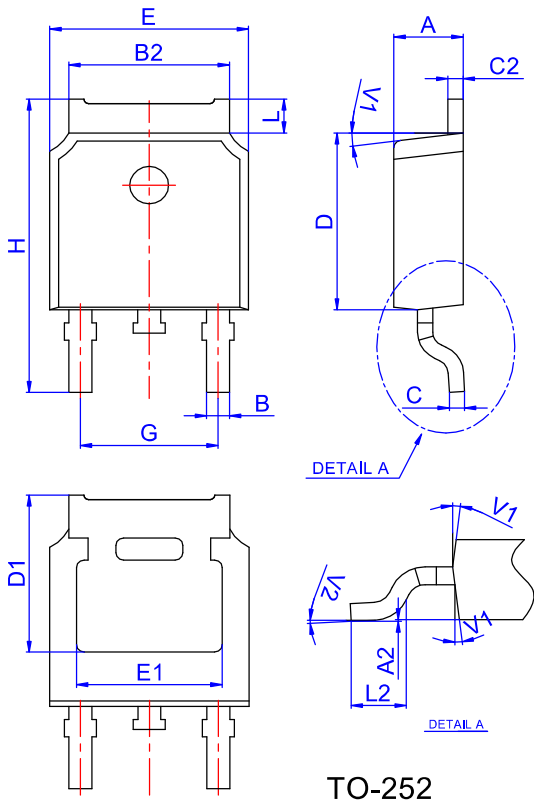

Figure 11 Normalized Maximum Transient Thermal Impedance

TO-252 Package Information



Ref.	Dimensions					
	Millimeters			Inches		
	Min.	Typ.	Max.	Min.	Typ.	Max.
A	2.10		2.50	0.083		0.098
A2	0		0.10	0		0.004
B	0.66		0.86	0.026		0.034
B2	5.18		5.48	0.202		0.216
C	0.40		0.60	0.016		0.024
C2	0.44		0.58	0.017		0.023
D	5.90		6.30	0.232		0.248
D1	5.30REF			0.209REF		
E	6.40		6.80	0.252		0.268
E1	4.63			0.182		
G	4.47		4.67	0.176		0.184
H	9.50		10.70	0.374		0.421
L	1.09		1.21	0.043		0.048
L2	1.35		1.65	0.053		0.065
V1		7°			7°	
V2	0°		6°	0°		6°

Reel Specification-TO-252

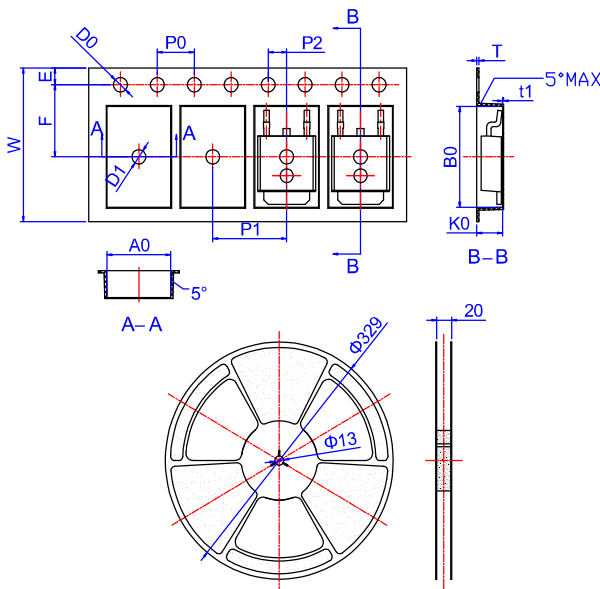

Ref.	Dimensions					
	Millimeters			Inches		
	Min.	Typ.	Max.	Min.	Typ.	Max.
W	15.90	16.00	16.10	0.626	0.630	0.634
E	1.65	1.75	1.85	0.065	0.069	0.073
F	7.40	7.50	7.60	0.291	0.295	0.299
D0	1.40	1.50	1.60	0.055	0.059	0.063
D1	1.40	1.50	1.60	0.055	0.059	0.063
P0	3.90	4.00	4.10	0.154	0.157	0.161
P1	7.90	8.00	8.10	0.311	0.315	0.319
P2	1.90	2.00	2.10	0.075	0.079	0.083
A0	6.85	6.90	7.00	0.270	0.271	0.276
B0	10.45	10.50	10.60	0.411	0.413	0.417
K0	2.68	2.78	2.88	0.105	0.109	0.113
T	0.24		0.27	0.009		0.011
t1	0.10			0.004		
10P0	39.80	40.00	40.20	1.567	1.575	1.583