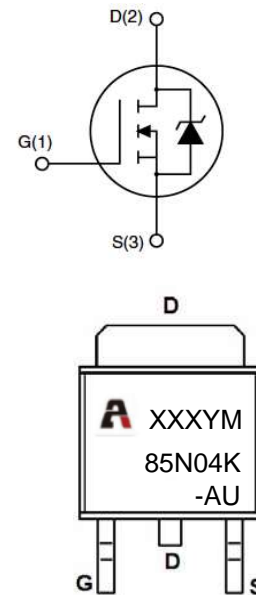


## Features

- 40V,65A  
 $R_{DS(ON)} < 5.9m\ \Omega @ V_{GS}=10V$  TYP:5.0m  $\Omega$   
 $R_{DS(ON)} < 10m\ \Omega @ V_{GS}=4.5V$  TYP:7.5m  $\Omega$
- Lead free and Green Device Available
- Excellent RDS(ON) and Low Gate Charge
- Lead free product Fast switching speed
- $T_{jmax}=175^{\circ}C$
- AEC-Q101 qualified

## Applications

- Load Switch
- PWM Application
- Power management



Marking and pin assignment

## Package Marking and Ordering Information

Device Marking	Device	Device Package	Reel Size	Tape width	Quantity (PCS)
85N04K-AU	AP85N04K-AU	TO-252	-	-	2500

## ABSOLUTE MAXIMUM RATINGS ( $T_J=25^{\circ}C$ unless otherwise noted)

Parameter	Symbol	Value	Unit
Drain-Source Voltage	$V_{DS}$	40	V
Gate-Source Voltage	$V_{GS}$	$\pm 20$	V
Continuous Drain Current ( $T_c = 25^{\circ}C$ )	$I_D$	65	A
Continuous Drain Current ( $T_c = 100^{\circ}C$ )	$I_D$	41	A
Pulsed Drain Current <sup>(1)</sup>	$I_{DM}$	260	A
Power Dissipation ( $T_a = 25^{\circ}C$ )	$P_D$	57	W
Thermal Resistance from Junction to Case	$R_{\theta JC}$	2.6	$^{\circ}C/W$
Thermal Resistance from Junction to Ambient	$R_{\theta JA}$	60	$^{\circ}C/W$
Junction Temperature	$T_J$	175	$^{\circ}C$
Storage Temperature	$T_{STG}$	-55~ +175	$^{\circ}C$

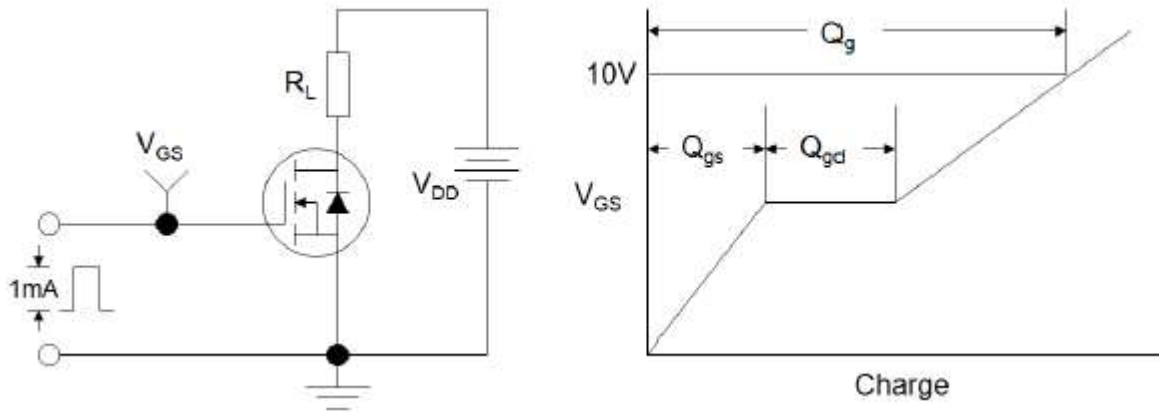
**MOSFET ELECTRICAL CHARACTERISTICS(T<sub>J</sub>=25°C unless otherwise noted)**

Parameter	Symbol	Test Condition	Min	Type	Max	Unit
<b>Static Characteristics</b>						
Drain-source breakdown voltage	V <sub>(BR)DSS</sub>	V <sub>GS</sub> = 0V, I <sub>D</sub> =250μA	40	-	-	V
Zero gate voltage drain current	I <sub>DSS</sub>	V <sub>DS</sub> =40V, V <sub>GS</sub> = 0V, T <sub>J</sub> =25°C	-	-	1	μA
Gate-body leakage current	I <sub>GSS</sub>	V <sub>GS</sub> = ±20V, V <sub>DS</sub> = 0V	-	-	±100	nA
Gate threshold voltage	V <sub>GS(th)</sub>	V <sub>DS</sub> =V <sub>GS</sub> , I <sub>D</sub> =250μA	1.0	1.5	2.2	V
Drain-source on-resistance <sup>(2)</sup>	R <sub>DS(on)</sub>	V <sub>GS</sub> =10V, I <sub>D</sub> =30A	-	5.0	5.9	mΩ
		V <sub>GS</sub> =4.5V, I <sub>D</sub> =20A		7.5	10	
<b>Dynamic characteristics</b>						
Input Capacitance	C <sub>iss</sub>	V <sub>DS</sub> =20V, V <sub>GS</sub> =0V, f =1.0MHz	-	2448	-	pF
Output Capacitance	C <sub>oss</sub>		-	396	-	
Reverse Transfer Capacitance	C <sub>rss</sub>		-	200	-	
<b>Switching characteristics</b>						
Turn-on delay time	t <sub>d(on)</sub>	V <sub>DD</sub> =20V, I <sub>D</sub> =20A, R <sub>L</sub> =1Ω, R <sub>G</sub> =3Ω V <sub>GS</sub> =10V	-	13	-	ns
Turn-on rise time	t <sub>r</sub>		-	11	-	
Turn-off delay time	t <sub>d(off)</sub>		-	41	-	
Turn-off fall time	t <sub>f</sub>		-	14	-	
Total Gate Charge	Q <sub>g</sub>	V <sub>DS</sub> =20V, I <sub>D</sub> =30A, V <sub>GS</sub> =4.5V	-	56	-	nC
Gate-Source Charge	Q <sub>gs</sub>		-	5	-	
Gate-Drain Charge	Q <sub>gd</sub>		-	13.5	-	
<b>Source-Drain Diode characteristics</b>						
Diode Forward voltage	V <sub>SD</sub>	T <sub>J</sub> =25°C, V <sub>GS</sub> =0V, I <sub>S</sub> =30A	-	-	1.2	V
Diode Forward current	I <sub>S</sub>	T <sub>C</sub> =25°C	-	-	65	A
Body Diode Reverse Recovery Time	t <sub>rr</sub>	T <sub>J</sub> =25°C, I <sub>F</sub> =30A, di/dt=100A/us		22		ns
Body Diode Reverse Recovery Charge	Q <sub>rr</sub>	T <sub>J</sub> =25°C, I <sub>F</sub> =30A, di/dt=100A/us		11		uc

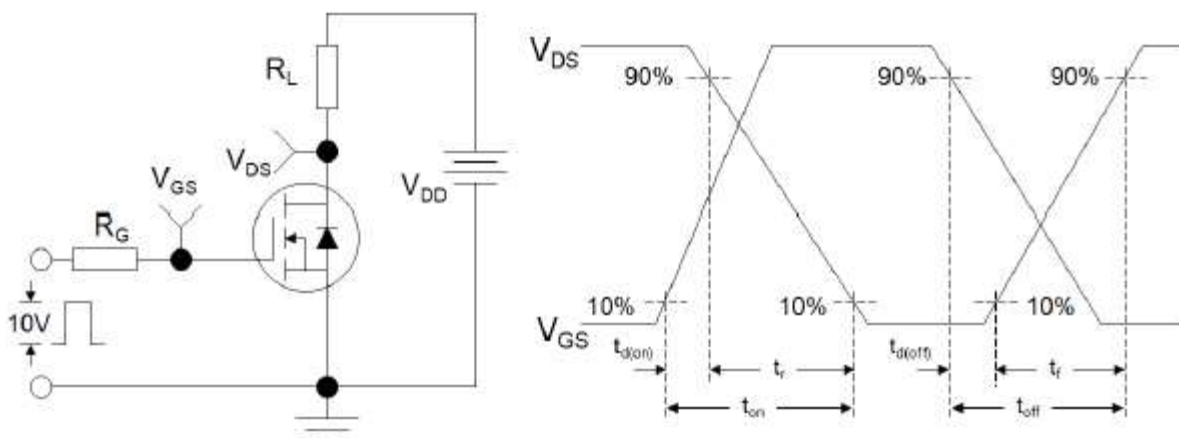
Notes:1. Repetitive Rating: Pulse Width Limited by Maximum Junction Temperature

2. Pulse Test: Pulse Width≤300μs, Duty Cycle≤0.5%

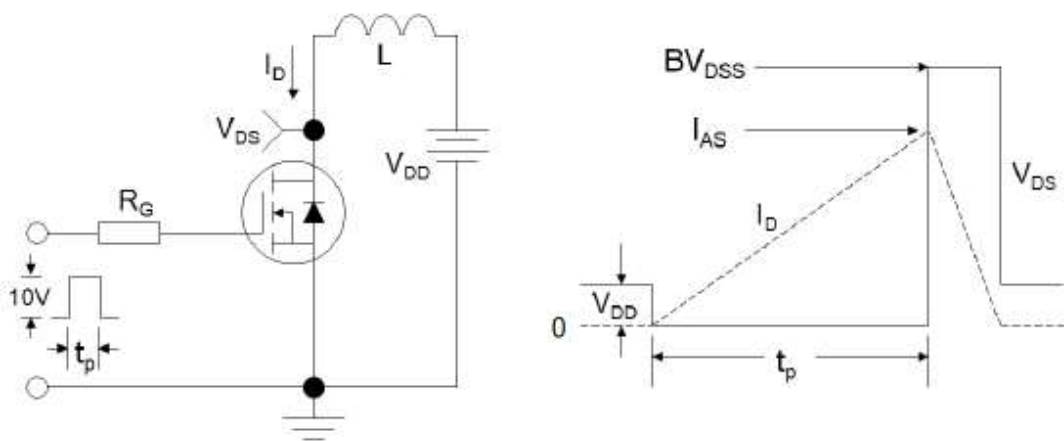
**Test Circuit**



**Figure1:Gate Charge Test Circuit & Waveform**



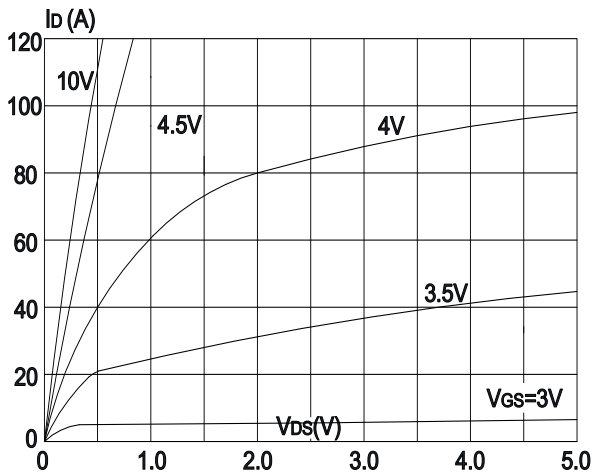
**Figure 2: Resistive Switching Test Circuit & Waveforms**



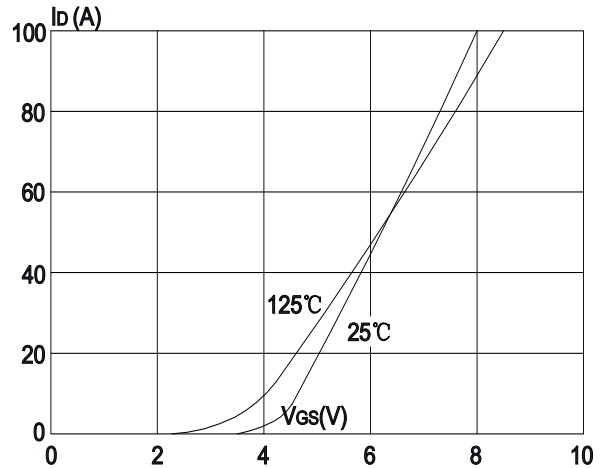
**Figure 3:Unclamped Inductive Switching Test Circuit & Waveforms**

**Typical Performance Characteristics**

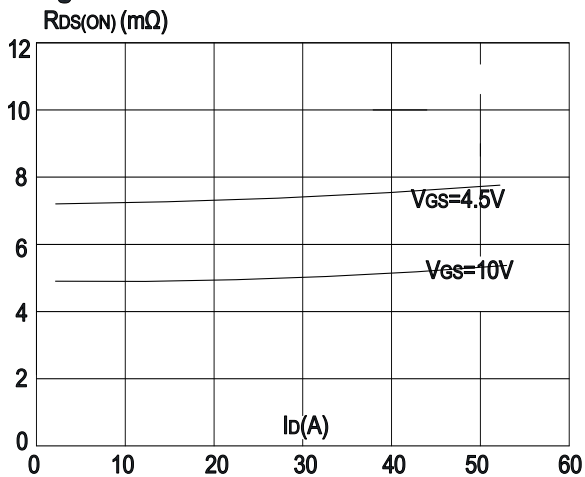
**Figure 1: Output Characteristics**



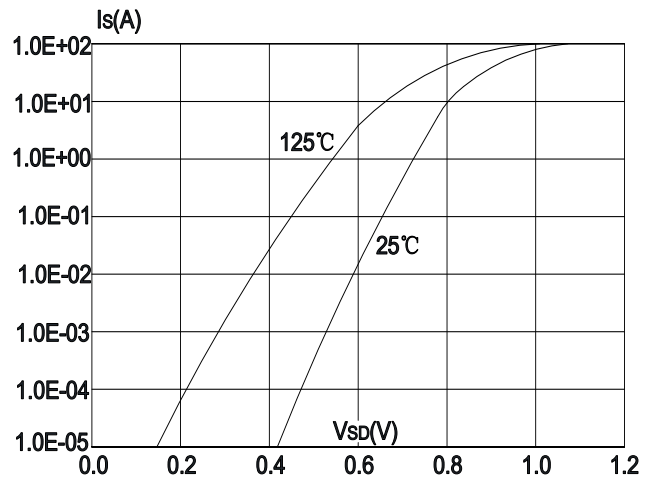
**Figure 2: Typical Transfer Characteristics**



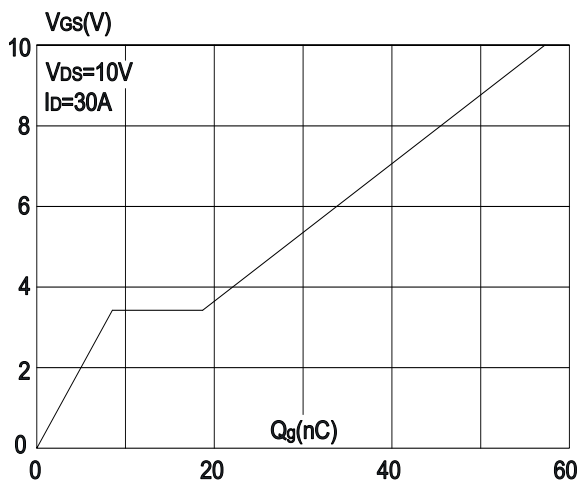
**Figure 3: On-resistance vs. Drain Current**



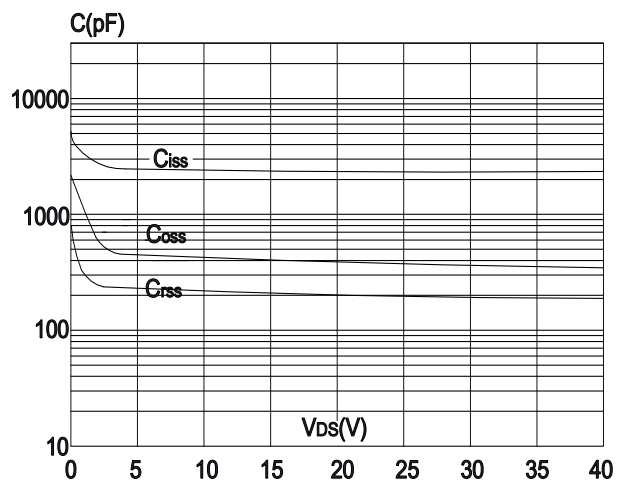
**Figure 4: Body Diode Characteristics**



**Figure 5: Gate Charge Characteristics**

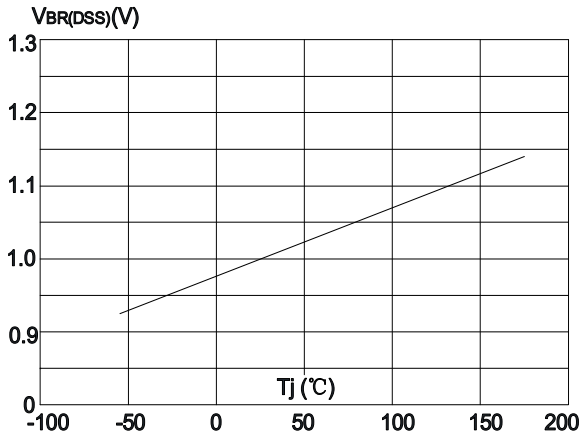


**Figure 6: Capacitance Characteristics**

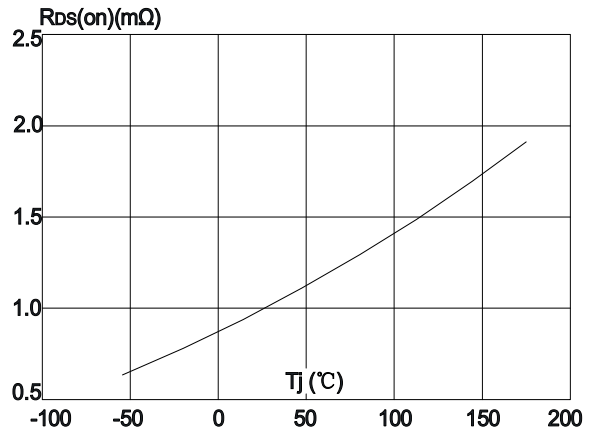


**Typical Performance Characteristics**

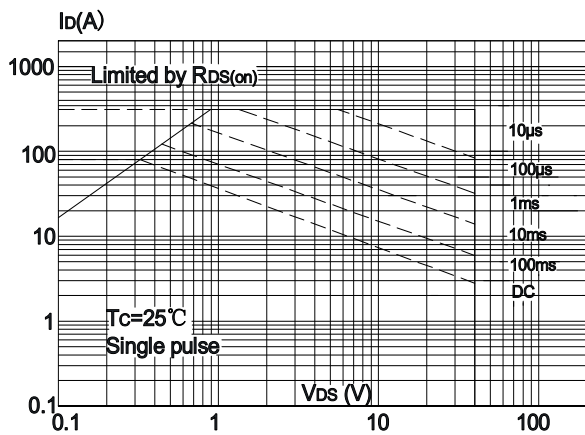
**Figure 7: Normalized Breakdown Voltage vs. Junction Temperature**



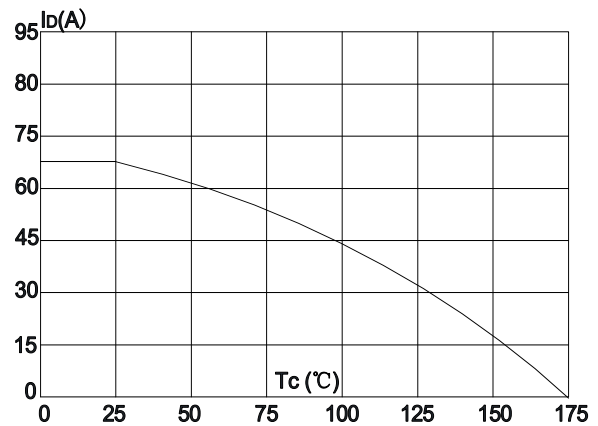
**Figure 8: Normalized on Resistance vs. Junction Temperature**



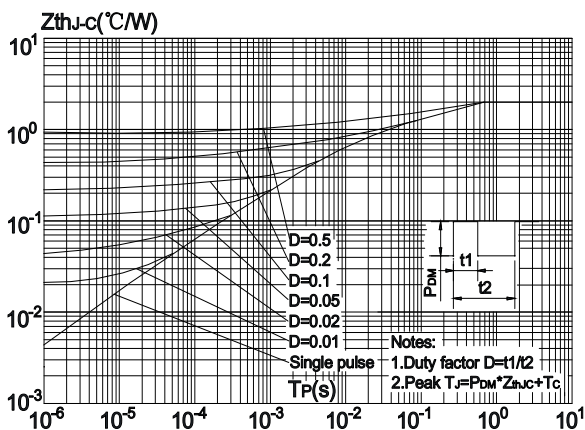
**Figure 9: Maximum Safe Operating Area**



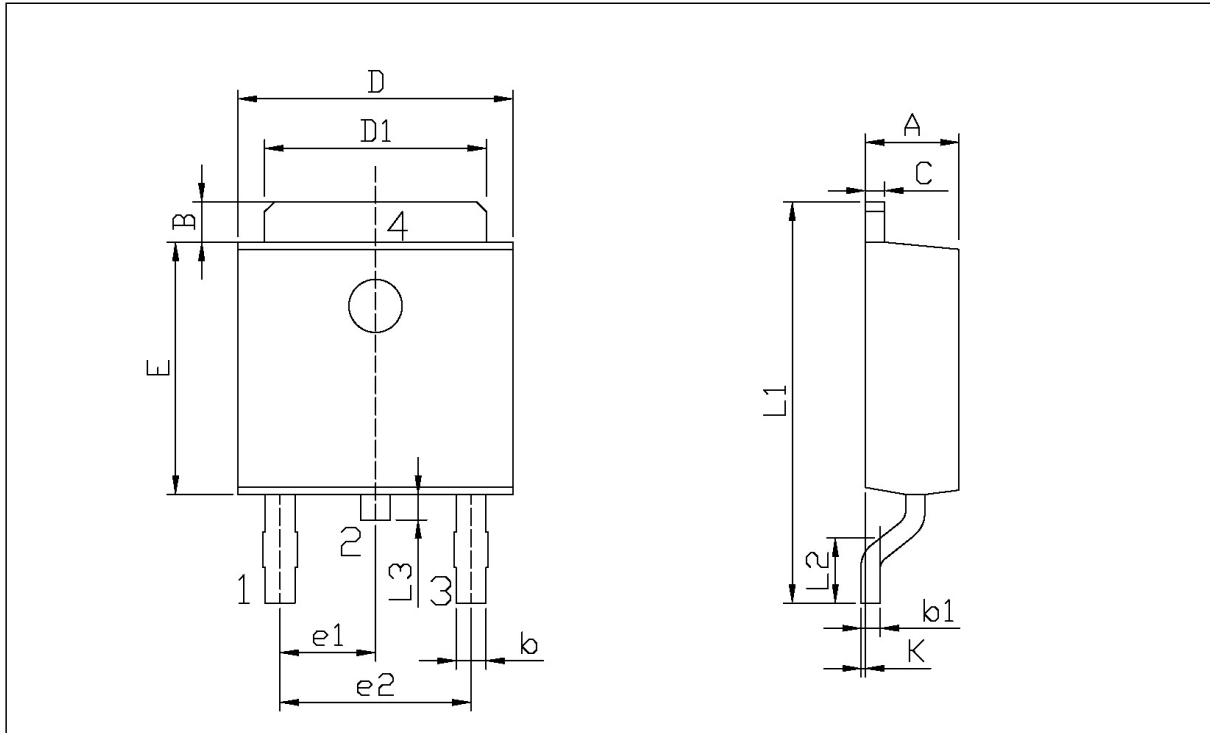
**Figure 10: Maximum Continuous Drain Current vs. Case Temperature**



**Figure.11: Maximum Effective Transient Thermal Impedance, Junction-to-Case**



**TO-252 Package Information**



单位: mm

Symbol	Dimensions In Millimeters		Symbol	Dimensions In Millimeters	
	Min	Max		Min	Max
A	2.20	2.40	E	5.95	6.25
B	0.95	1.25	e1	2.24	2.34
b	0.50	0.90	e2	4.43	4.73
b1	0.45	0.55	L1	9.45	9.95
C	0.45	0.55	L2	1.25	1.75
D	6.45	6.75	L3	0.60	0.90
D1	5.10	5.50	K	0.00	0.10

TO-252

## Revision History

Revision	Release	Remark
V1.0	2022/11/28	Initial Release

## Disclaimer

The information given in this document describes the independent performance of the product, but similar performance is not guaranteed under other working conditions, and cannot be guaranteed when installed with other products or equipment. To achieve the required performance of the product in actual scenarios, the customer should conduct a complete application test to assess the functionality of the product.

Allpower assumes no responsibility for equipment failures result from using products at values that exceed the ratings, operating conditions, or other parameters listed in the product specifications.

The product described in this specification is not applicable for aerospace or other applications which requires high reliability. Customers using or selling these products for use in medical, life-saving, or life-sustaining applications do so at their own risk and agree to fully indemnify.

Due to product or technical improvements, the information described or contained herein may be changed without prior notice.