

Feature

- 40V,20A
 $R_{DS(ON)} < 15m\Omega @ V_{GS}=10V$ TYP:13 m Ω
 $R_{DS(ON)} < 20m\Omega @ V_{GS}=4.5V$ TYP:17 m Ω
- Advanced Trench Technology
- Lead free product is acquired
- Excellent $R_{DS(ON)}$ and Low Gate Charge
- $T_{jmax}=175^{\circ}C$
- AEC-Q101 qualified

Application

- PWM applications
- Load Switch
- Power management

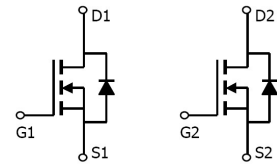

Schematic diagram

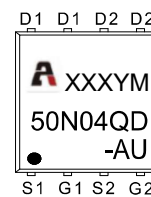

Marking and pin assignment

Package Marking and Ordering Information

Device Marking	Device	Device Package	Reel Size	Tape width	Quantity (PCS)
50N04QD-AU	AP50N04QD-AU	PDFN3X3	13 inch	-	5000

ABSOLUTE MAXIMUM RATINGS ($T_J=25^{\circ}C$ unless otherwise noted)

Parameter	Symbol	Value	Unit
Drain-Source Voltage	V_{DS}	40	V
Gate-Source Voltage	V_{GS}	± 20	V
Continuous Drain Current ($T_c = 25^{\circ}C$)	I_D	20	A
Continuous Drain Current ($T_c = 100^{\circ}C$)	I_D	14	A
Pulsed Drain Current ⁽¹⁾	I_{DM}	60	A
Single Pulsed Avalanche Energy ⁽²⁾	E_{AS}	12.25	mJ
Power Dissipation	P_D	41	W
Thermal Resistance from Junction to Case ⁽⁴⁾	$R_{\theta JC}$	3.6	$^{\circ}C/W$
Junction Temperature	T_J	175	$^{\circ}C$
Storage Temperature	T_{STG}	-55~ +175	$^{\circ}C$

MOSFET ELECTRICAL CHARACTERISTICS(T_J=25°C unless otherwise noted)

Parameter	Symbol	Test Condition	Min	Type	Max	Unit
Static Characteristics						
Drain-source breakdown voltage	V _{(BR)DSS}	V _{GS} = 0V, I _D =250μA	40	-	-	V
Zero gate voltage drain current	I _{DSS}	V _{DS} =40V, V _{GS} = 0V	-	-	1	μA
Gate-body leakage current	I _{GSS}	V _{GS} =±20V, V _{DS} = 0V	-	-	±100	nA
Gate threshold voltage ⁽³⁾	V _{GS(th)}	V _{DS} =V _{GS} , I _D =250μA	1	1.5	2.5	V
Drain-source on-resistance ⁽³⁾	R _{DS(on)}	V _{GS} =10V, I _D =10A	-	13	15	mΩ
		V _{GS} =4.5V, I _D =8A	-	17	20	
Dynamic characteristics						
Input Capacitance	C _{iss}	V _{DS} =20V, V _{GS} =0V, f =1MHz	-	1250	-	pF
Output Capacitance	C _{oss}		-	114	-	
Reverse Transfer Capacitance	C _{rss}		-	85	-	
Switching characteristics						
Turn-on delay time	t _{d(on)}	V _{DD} =20V, I _D =1A, R _L =6Ω V _{GS} =10V, R _G =1Ω	-	10	-	ns
Turn-on rise time	t _r		-	9	-	
Turn-off delay time	t _{d(off)}		-	32	-	
Turn-off fall time	t _f		-	16	-	
Total Gate Charge	Q _g	V _{DS} =20V, I _D =10A, V _{GS} =10V	-	20	-	nC
Gate-Source Charge	Q _{gs}		-	3.5	-	
Gate-Drain Charge	Q _{gd}		-	4.2	-	
Source-Drain Diode characteristics						
Diode Forward voltage ⁽³⁾	V _{DS}	V _{GS} =0V, I _S =10A	-	-	1.2	V
Diode Forward current ⁽⁴⁾	I _S		-	-	20	A

Notes:

1. Repetitive Rating: pulse width limited by maximum junction temperature
2. EAS Condition: T_J=25°C, V_{DD}=20V, R_G=25 Ω, L=0.5mH
3. Pulse Test: pulse width≤300μs, duty cycle≤2%
4. Surface Mounted on FR4 Board, t≤10 sec

Test Circuit

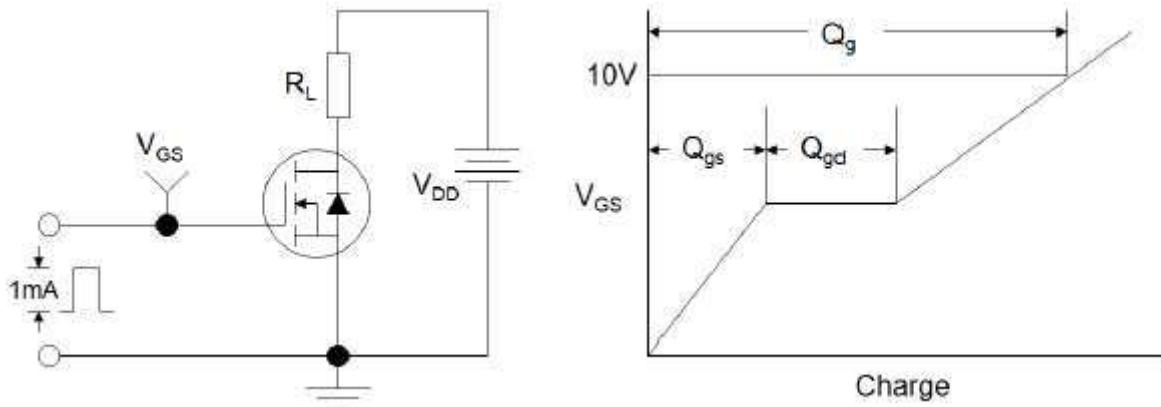

Figure1:Gate Charge Test Circuit & Waveform

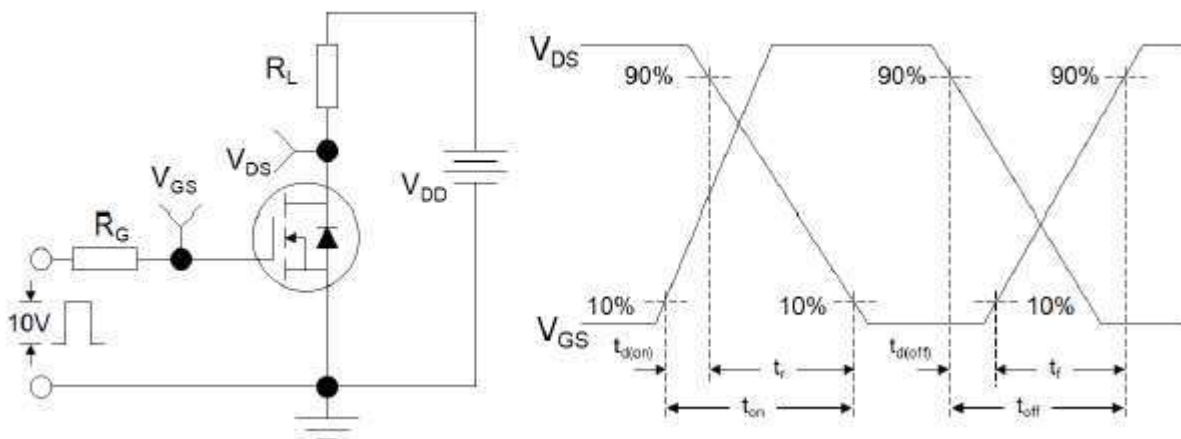

Figure 2: Resistive Switching Test Circuit & Waveforms

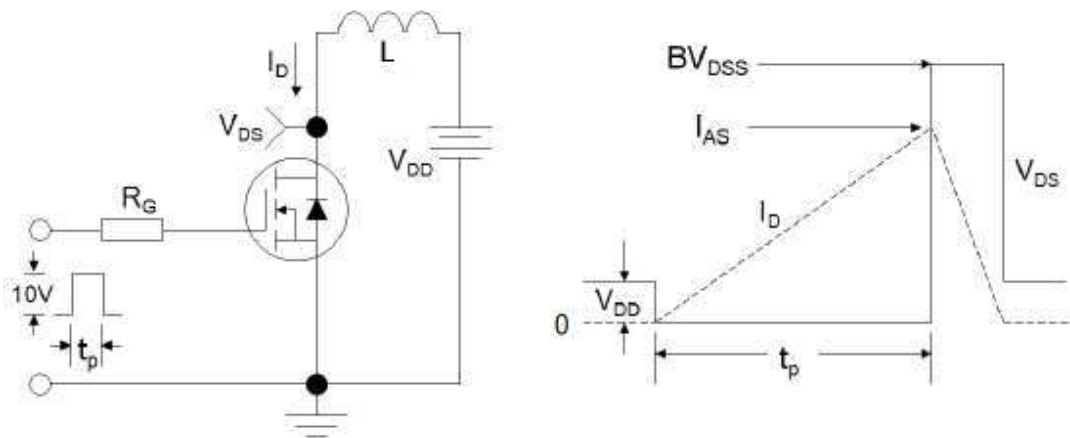

Figure 3:Unclamped Inductive Switching Test Circuit & Waveforms

Typical Performance Characteristics

Figure 1: Output Characteristics

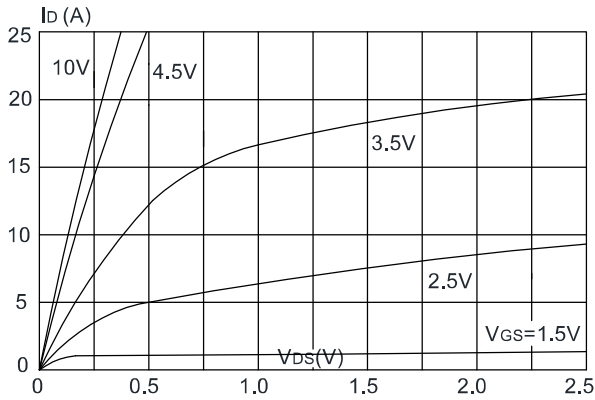

Figure 2: Typical Transfer Characteristics

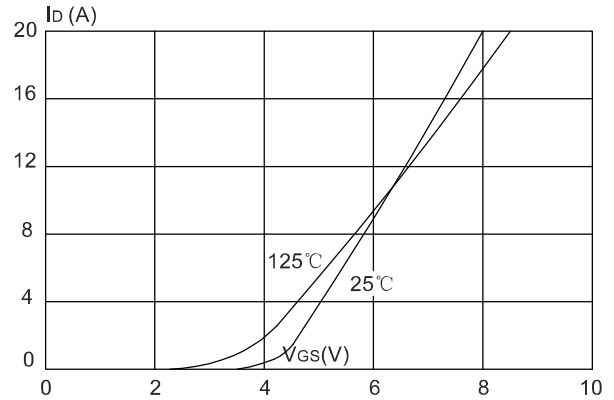

Figure 3: On-resistance vs. Drain Current

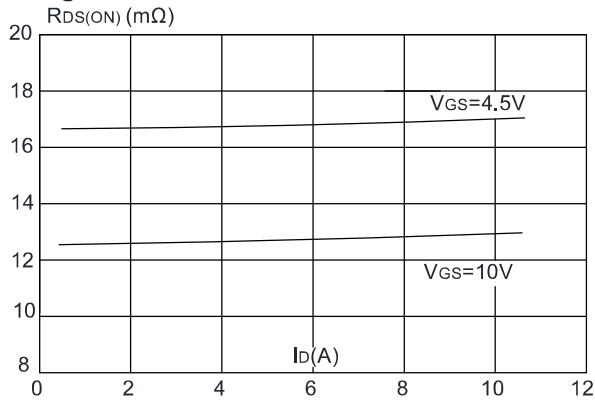

Figure 4: Body Diode Characteristics

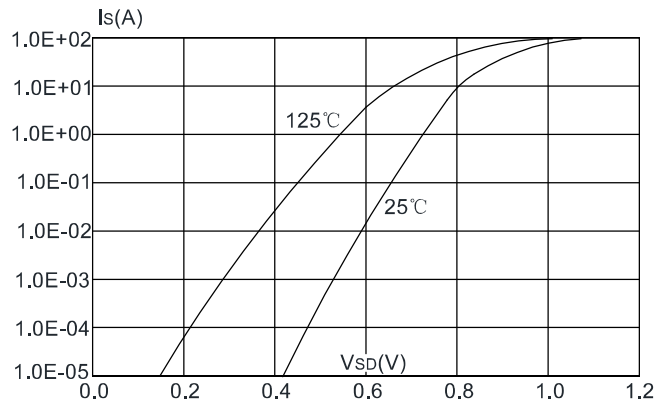

Figure 5: Gate Charge Characteristics

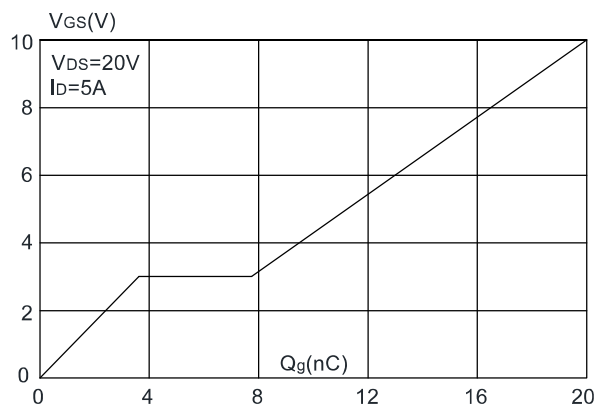

Figure 6: Capacitance Characteristics

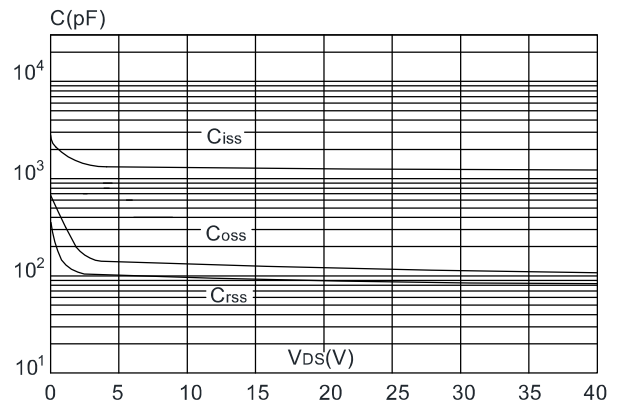

Figure 7: Normalized Breakdown Voltage vs. Junction Temperature

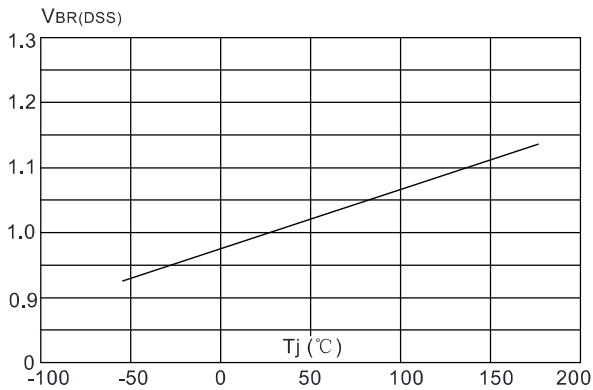

Figure 8: Normalized on Resistance vs. Junction Temperature

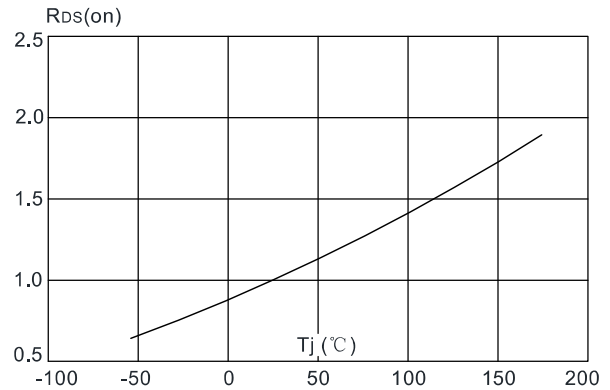

Figure 9: Maximum Safe Operating Area

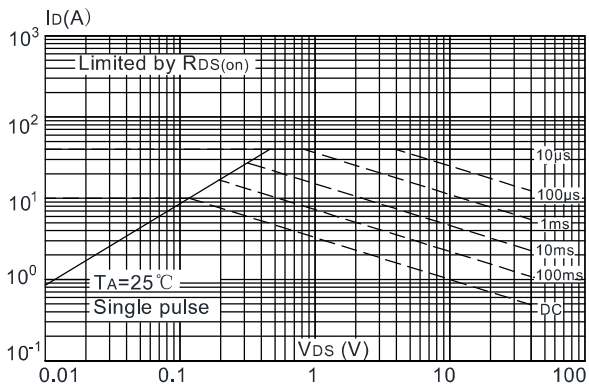

Figure 10: Maximum Continuous Drain Current vs. Ambient Temperature

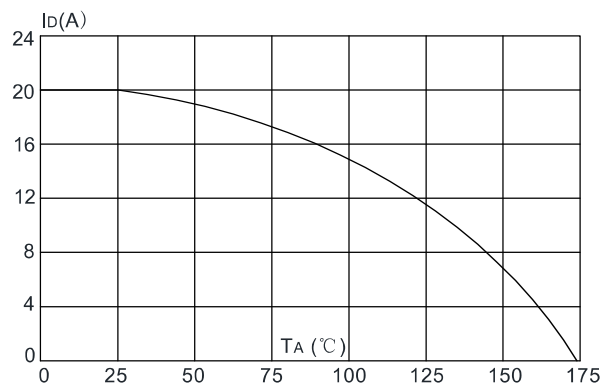
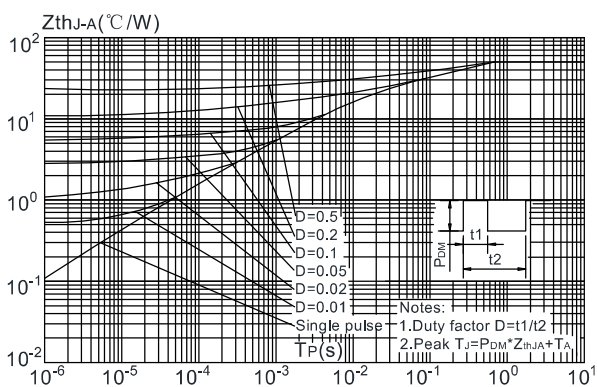
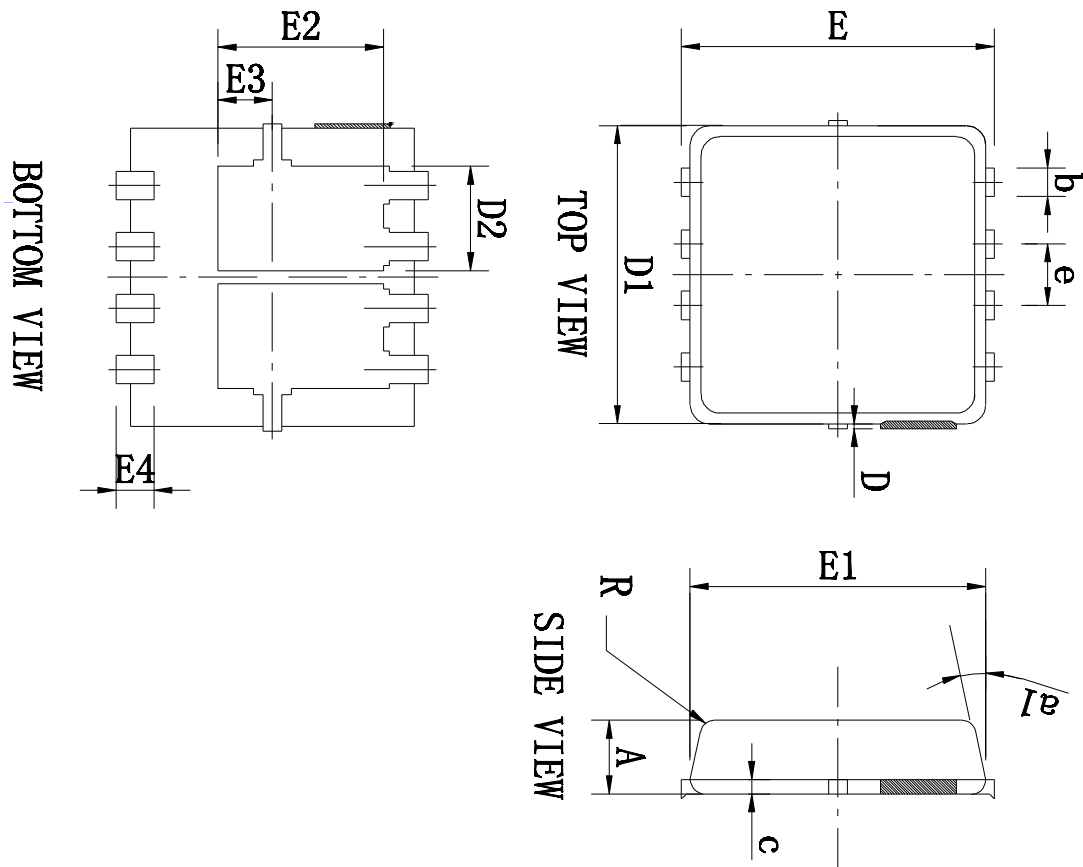

Figure.11: Maximum Effective Transient Thermal Impedance, Junction-to-Ambient



PDFN3X3 Package Information



Dimensions In Millimeterer			
Symbol	MIN	TYP	MAX
A	0.75	0.78	0.81
b	0.297	0.30	0.35
c	--	0.152	--
D0	0.00	0.05	0.10
D1	3.12	3.15	3.18
D2	--	1.05	--
E	3.20	3.30	3.40
E1	3.09	3.12	3.15
E2	--	1.75	--
E3	--	0.575	--
E4	--	0.40	--
R	--	0.15	--
e	0.65BSC		
a1°	--	12°	--

Revision History

Revision	Release	Remark
V1.0	2022/12/21	Initial Release

Disclaimer

The information given in this document describes the independent performance of the product, but similar performance is not guaranteed under other working conditions, and cannot be guaranteed when installed with other products or equipment. To achieve the required performance of the product in actual scenarios, the customer should conduct a complete application test to assess the functionality of the product.

Allpower assumes no responsibility for equipment failures result from using products at values that exceed the ratings, operating conditions, or other parameters listed in the product specifications.

The product described in this specification is not applicable for aerospace or other applications which requires high reliability. Customers using or selling these products for use in medical, life-saving, or life-sustaining applications do so at their own risk and agree to fully indemnify.

Due to product or technical improvements, the information described or contained herein may be changed without prior notice.