

AP30P30Q

P-Channel Enhancement Mosfet

AIIPOWER

DATA SHEET

Feature

- -30V,-40A
 $R_{DS(ON)} < 9m\Omega @ V_{GS} = -10V$
 $R_{DS(ON)} < 13m\Omega @ V_{GS} = -4.5V$
- Trench DMOS Power MOSFET
- Fast Switching
- Exceptional on-resistance and maximum DC current capability

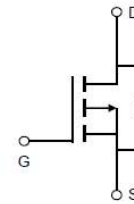

Schematic Diagram

Application

- DC/DC Converter
- Load Switch for Portable Devices
- Battery Switch

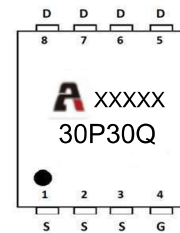

Marking and pin Assignment

Package Marking and Ordering Information

Device Marking	Device	Device Package	Reel Size	Tape width	Quantity (PCS)
30P30Q	AP30P30Q	PDFN3X3	13 inch	-	5000

ABSOLUTE MAXIMUM RATINGS ($T_a = 25^\circ\text{C}$ unless otherwise noted)

Parameter	Symbol	Value	Unit
Drain-Source Voltage	V_{DS}	-30	V
Gate-Source Voltage	V_{GS}	± 20	V
Continuous Drain Current ($T_a = 25^\circ\text{C}$)	I_D	-40	A
Continuous Drain Current ($T_a = 100^\circ\text{C}$)	I_D	-26	A
Pulsed Drain Current ⁽¹⁾	I_{DM}	-160	A
Single Pulsed Avalanche Energy ⁽²⁾	E_{AS}	156	mJ
Power Dissipation	P_D	32	W
Thermal Resistance from Junction to Ambient	$R_{\theta JA}$	50	$^\circ\text{C}/\text{W}$
Junction Temperature	T_J	150	$^\circ\text{C}$
Storage Temperature	T_{STG}	-55~ +150	$^\circ\text{C}$

MOSFET ELECTRICAL CHARACTERISTICS($T_a=25^{\circ}\text{C}$ unless otherwise noted)

Parameter	Symbol	Test Condition	Min	Type	Max	Unit
Static Characteristics						
Drain-source breakdown voltage	$V_{(BR)DSS}$	$V_{GS} = 0V, I_D = -250\mu A$	-30	-	-	V
Zero gate voltage drain current	I_{DSS}	$V_{DS} = -30V, V_{GS} = 0V$	-	-	1	μA
Gate-body leakage current	I_{GSS}	$V_{GS} = \pm 20V, V_{DS} = 0V$	-	-	± 100	nA
Gate threshold voltage ⁽³⁾	$V_{GS(th)}$	$V_{DS} = V_{GS}, I_D = -250\mu A$	-1	-1.6	-2.2	V
Drain-source on-resistance ⁽³⁾	$R_{DS(on)}$	$V_{GS} = -10V, I_D = -20A$	-	7	9	m Ω
		$V_{GS} = -4.5V, I_D = -10A$	-	10	13	
Forward tranconductance ⁽³⁾	g_{FS}	$V_{DS} = -5V, I_D = -20A$	20	-	-	S
Dynamic characteristics						
Input Capacitance	C_{iss}	$V_{DS} = -15V, V_{GS} = 0V, f = 1MHz$	-	3142	-	pF
Output Capacitance	C_{oss}		-	424	-	
Reverse Transfer Capacitance	C_{rss}		-	420	-	
Switching characteristics						
Turn-on delay time	$t_{d(on)}$	$V_{DS} = -15V, I_D = -20A$ $V_{GS} = -10V, R_G = 2.5 \Omega$	-	13	-	ns
Turn-on rise time	t_r		-	47	-	
Turn-off delay time	$t_{d(off)}$		-	99	-	
Turn-off fall time	t_f		-	22	-	
Total Gate Charge	Q_g	$V_{DS} = -15V, I_D = -20A,$ $V_{GS} = -10V$	-	65	-	nC
Gate-Source Charge	Q_{gs}		-	9	-	
Gate-Drain Charge	Q_{gd}		-	15	-	
Source-Drain Diode characteristics						
Diode Forward voltage ⁽³⁾	V_{DS}	$V_{GS} = 0V, I_S = -20A$	-	-	-1.2	V
Diode Forward current ⁽⁴⁾	I_S		-	-	-40	A

Notes:

1. Repetitive Rating: pulse width limited by maximum junction temperature
2. EAS Condition: $T_J = 25^{\circ}\text{C}, V_{DD} = -15V, R_G = 20 \Omega, L = 0.5\text{mH}$
3. Pulse Test: pulse width $\leq 300\mu\text{s}$, duty cycle $\leq 2\%$
4. Surface Mounted on FR4 Board, $t \leq 10 \text{ sec}$

Test Circuit & Waveform

Gate Charge Test Circuit & Waveform

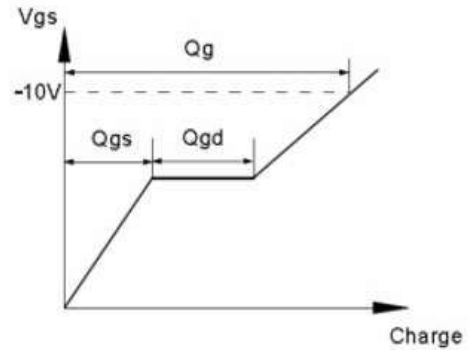
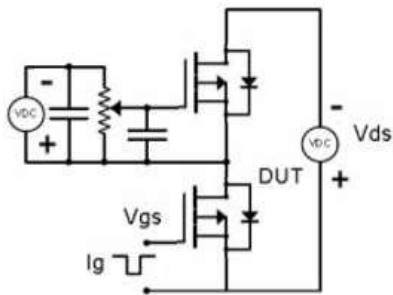

Resistive Switching Test Circuit & Waveforms

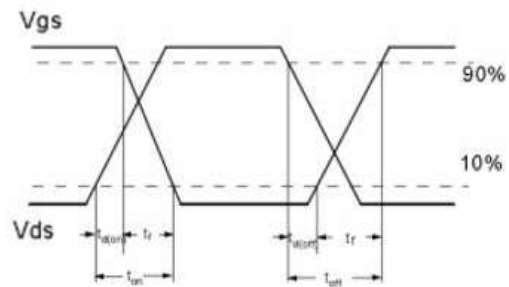
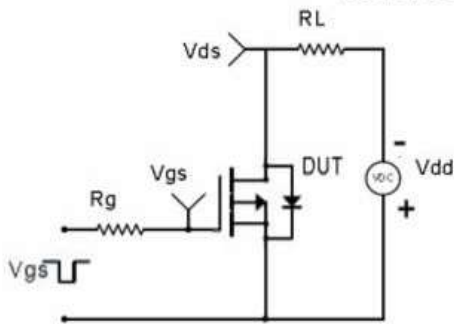

Unclamped Inductive Switching (UIS) Test Circuit & Waveforms

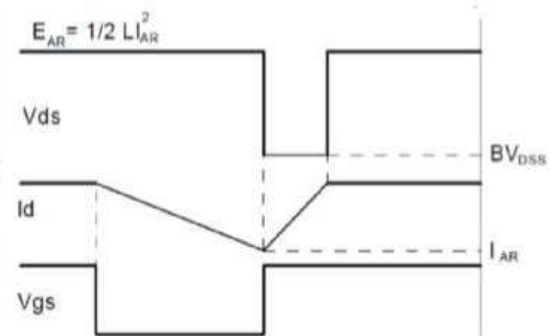
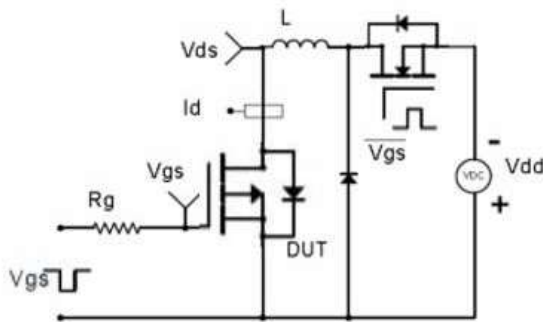

Diode Recovery Test Circuit & Waveforms

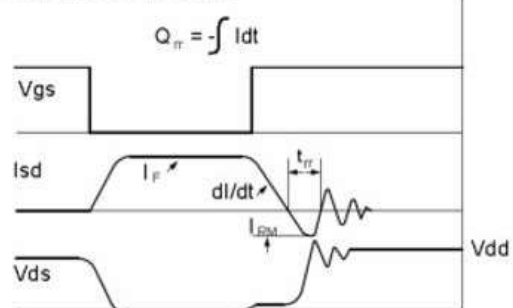
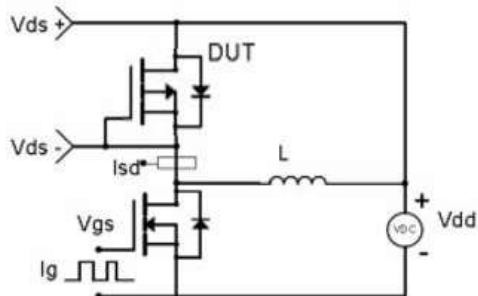

Typical Performance Characteristics

Fig.1 Power Dissipation Derating Curve

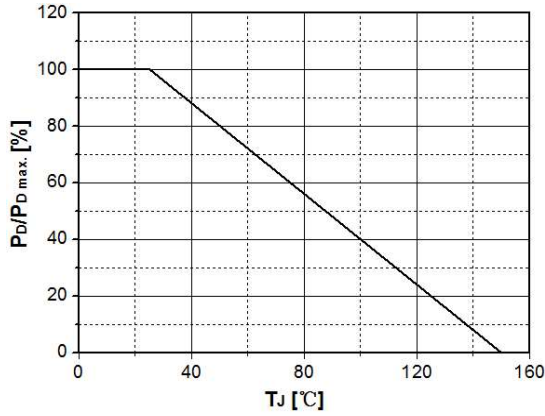

Fig.2 Avalanche Energy Derating Curve vs. Junction Temperature

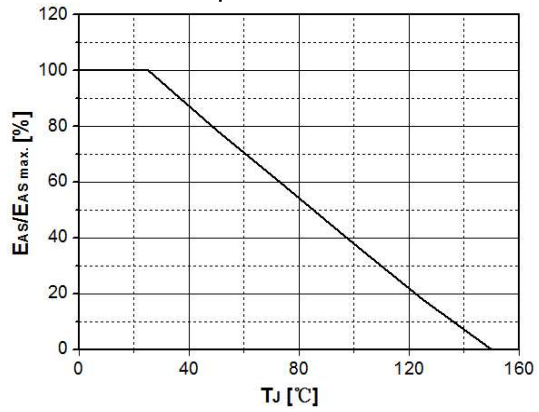

Fig.3 Typical Output Characteristics

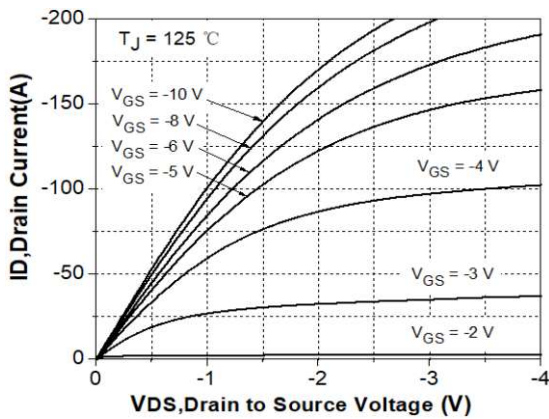

Fig. 4 Transconductance vs. Drain Current

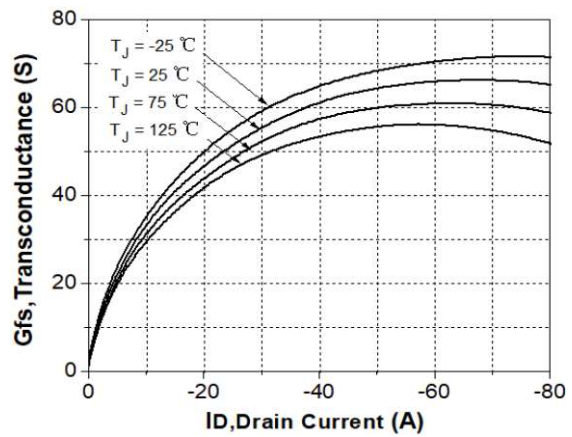

Fig.5 Typical Transfer Characteristics

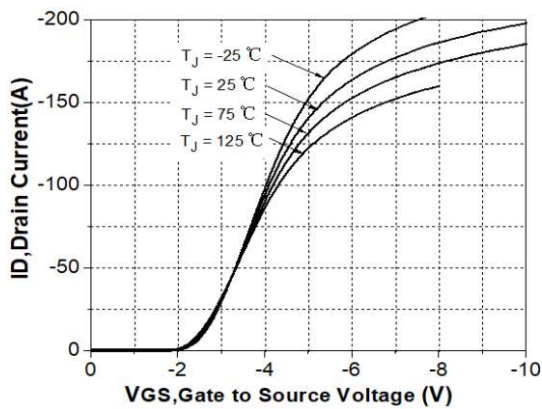

Fig. 6 State Resistance vs. Drain Current @-25°C

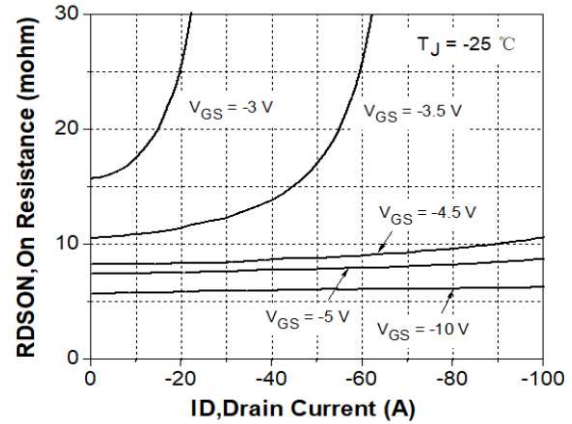

Fig.7 State Resistance vs. Drain Current @25°C

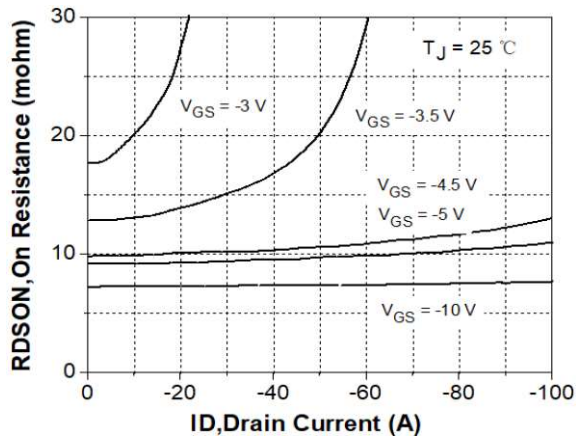

Fig. 8 State Resistance vs. Drain Current @125°C

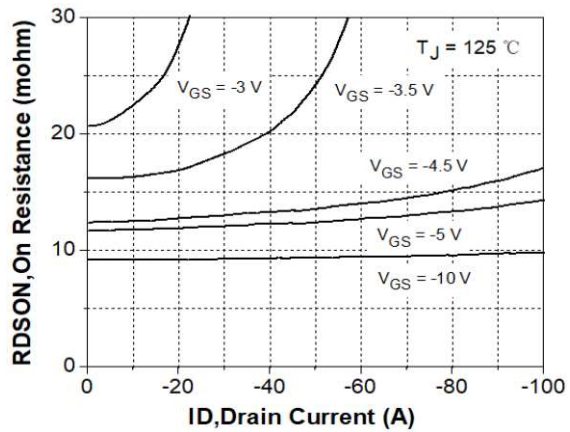

Fig.9 Typical Capacitance vs. Drain Source Voltage

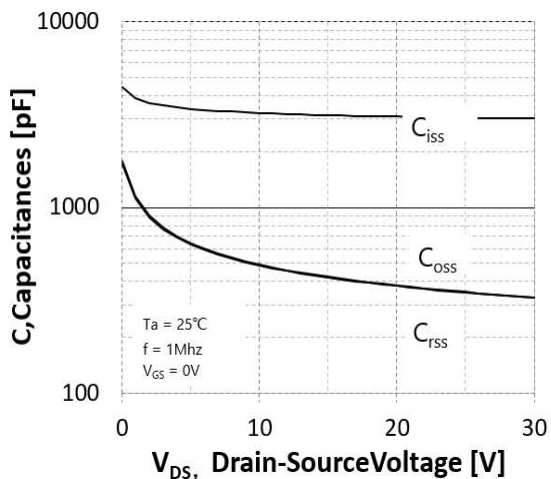

Fig.10 Dynamic Input Characteristics

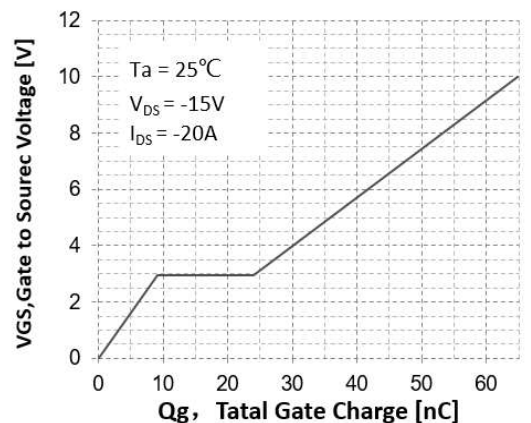

Fig.11 Breakdown Voltage vs. Junction Temperature

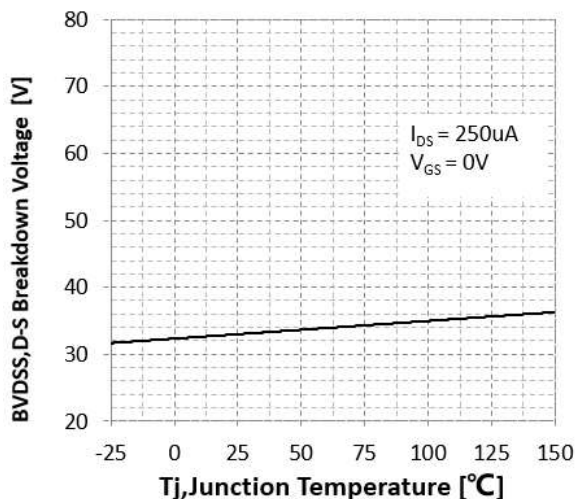

Fig. 12 Gate Threshold Voltage vs. Junction Temperature

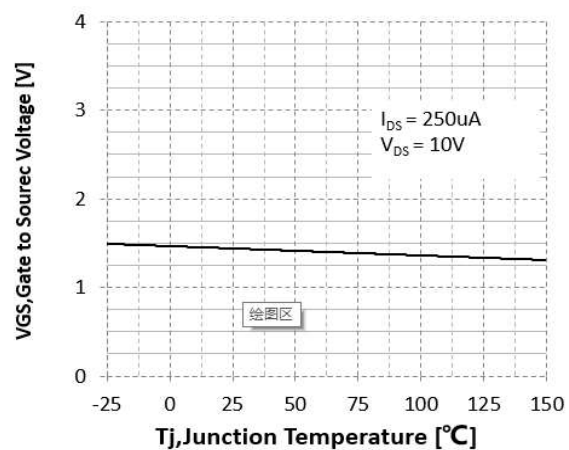

Fig.13 On-Resistance Variation vs. Junction Temperature

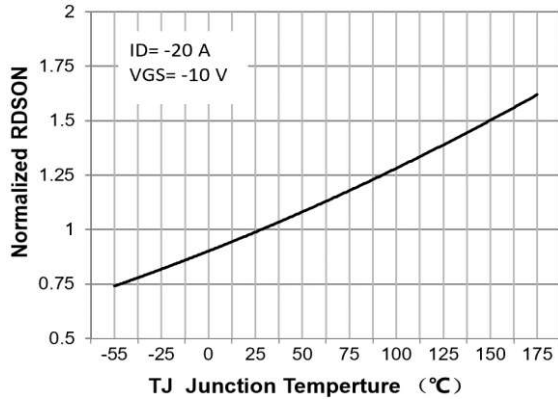

Fig.14 Maximum Drain Current vs. Case Temperature

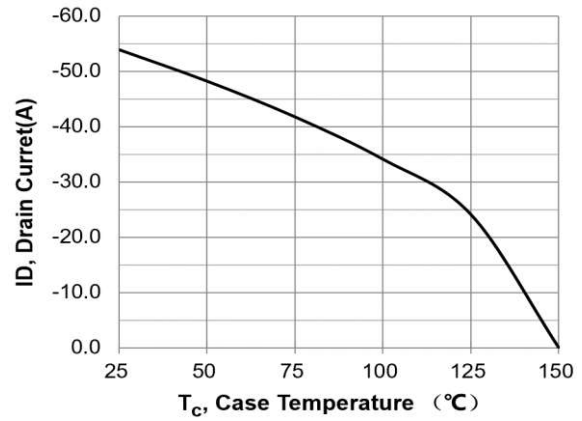

Fig.15 Body Diode Forward Voltage Vs Reverse Drain Current

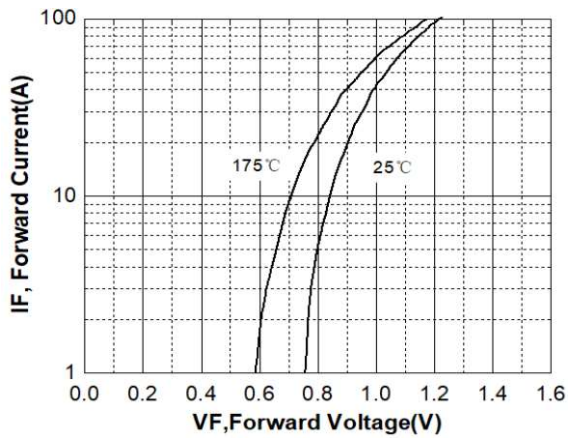

Fig.16 Safe Operating Area

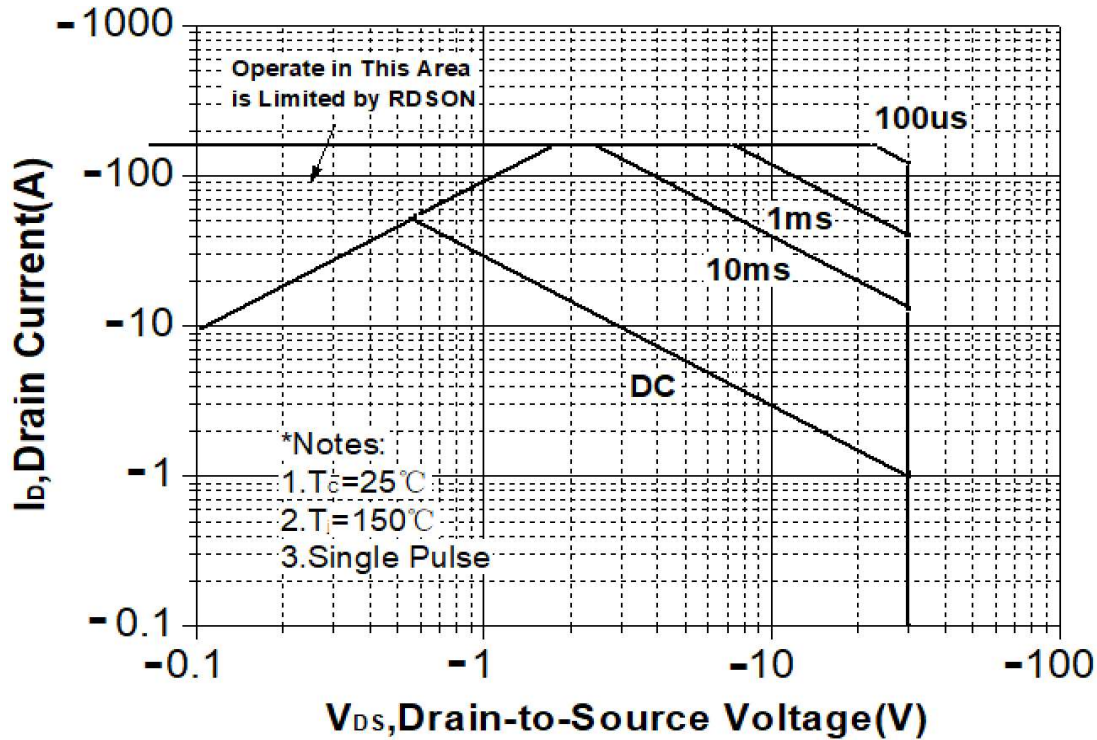
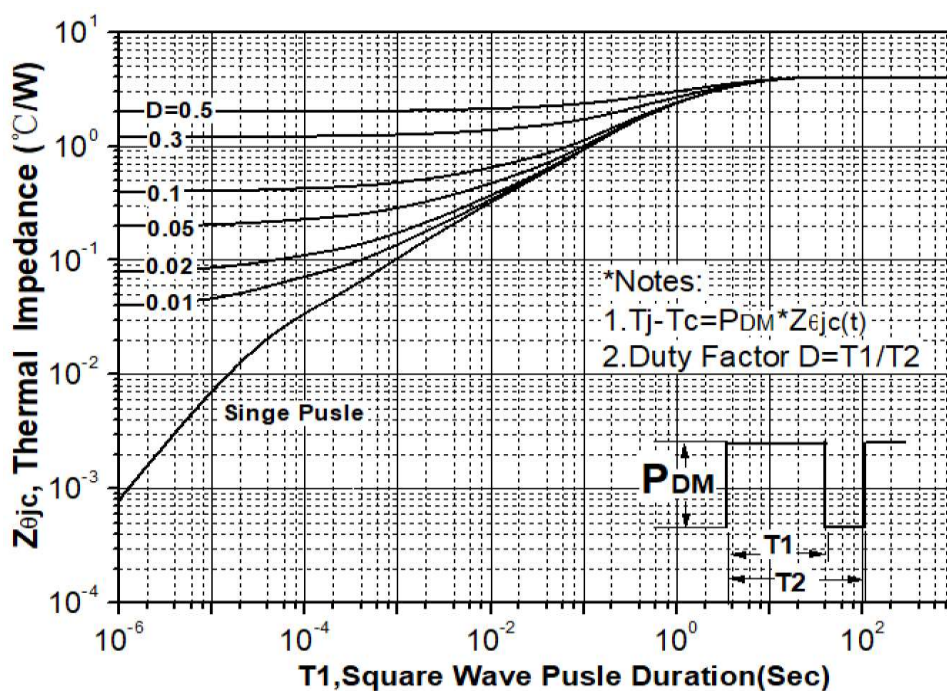

Fig. 17 Transient Thermal Response Curve



AP30P30Q

P-Channel Enhancement Mosfet

PDFN3X3-8L Package Information

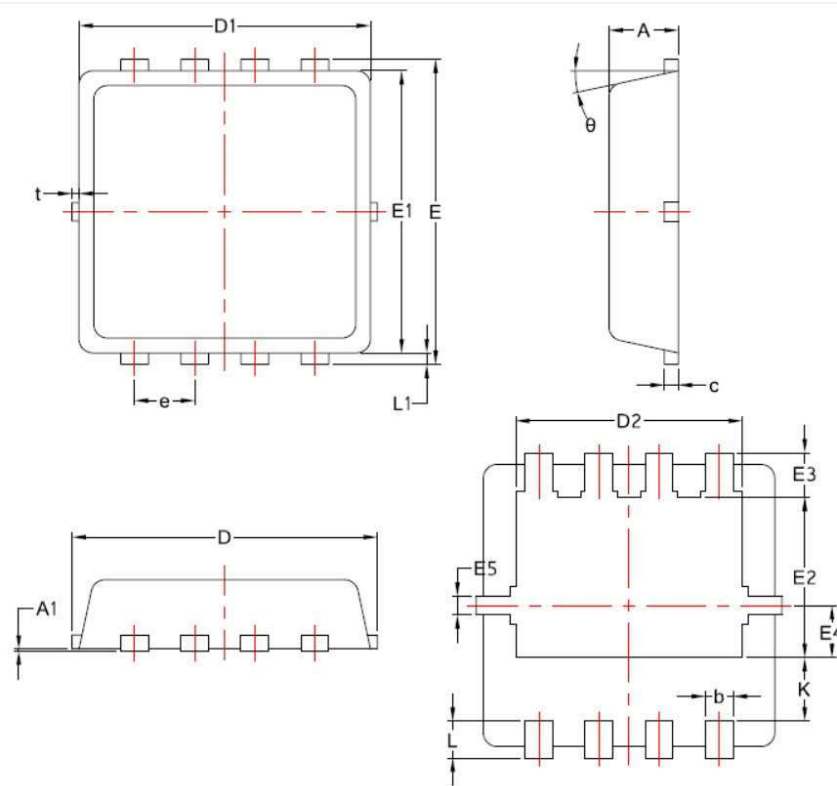

SYMBOL	COMMON		
	MM		
	MIN	NOM	MAX
A	0.70	0.75	0.85
A1	/	/	0.05
b	0.20	0.30	0.40
c	0.10	0.152	0.25
D	3.15	3.30	3.45
D1	3.00	3.15	3.25
D2	2.29	2.45	2.65
E	3.15	3.30	3.45
E1	2.90	3.05	3.20
E2	1.54	1.74	1.94
E3	0.28	0.48	0.65
E4	0.37	0.57	0.77
E5	0.10	0.20	0.30
e	0.60	0.65	0.70
K	0.59	0.69	0.89
L	0.30	0.40	0.50
L1	0.06	0.125	0.20
t	0	0.075	0.13
θ	10°	12°	14°