

AP90N03GD

N-Channel Enhancement Mosfet

AIIPOWER

DATA SHEET

Feature

- 30V,80A
 $R_{DS(ON)} < 5.8 \Omega @ V_{GS}=10V$ TYP:5.2 m Ω
 $R_{DS(ON)} < 9.5m \Omega @ V_{GS}=4.5V$ TYP:6.8 m Ω
- Advanced Trench Technology
- Lead free product is acquired
- Excellent $R_{DS(ON)}$ and Low Gate Charge

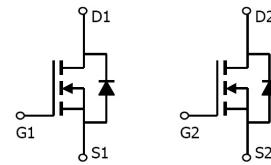

Schematic diagram

Application

- PWM applications
- Load Switch
- Power management



Marking and pin assignment

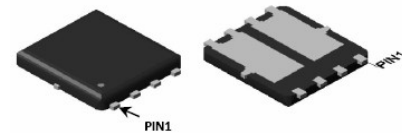

Top View

Bottom View

Package Marking and Ordering Information

Device Marking	Device	Device Package	Reel Size	Tape width	Quantity (PCS)
90N03GD	AP90N03GD	PDFN5X6-8L	13 inch	-	5000

ABSOLUTE MAXIMUM RATINGS ($T_a=25^\circ\text{C}$ unless otherwise noted)

Parameter	Symbol	Value	Unit
Drain-Source Voltage	V_{DS}	30	V
Gate-Source Voltage	V_{GS}	± 20	V
Continuous Drain Current ($T_a = 25^\circ\text{C}$)	I_D	80	A
Continuous Drain Current ($T_a = 100^\circ\text{C}$)	I_D	47	A
Pulsed Drain Current ⁽¹⁾	I_{DM}	330	A
Singel Pulsed Avalanche Energy ⁽²⁾	E_{AS}	180	mJ
Power Dissipation	P_D	90	W
Thermal Resistance from Junction to Case ⁽⁴⁾	$R_{\theta JC}$	2.5	$^\circ\text{C}/\text{W}$
Junction Temperature	T_J	150	$^\circ\text{C}$
Storage Temperature	T_{STG}	-55~ +150	$^\circ\text{C}$

MOSFET ELECTRICAL CHARACTERISTICS($T_a=25^{\circ}\text{C}$ unless otherwise noted)

Parameter	Symbol	Test Condition	Min	Type	Max	Unit
Static Characteristics						
Drain-source breakdown voltage	$V_{(BR)DSS}$	$V_{GS} = 0V, I_D = 250\mu A$	30	-	-	V
Zero gate voltage drain current	I_{DSS}	$V_{DS} = 30V, V_{GS} = 0V$	-	-	1	μA
Gate-body leakage current	I_{GSS}	$V_{GS} = \pm 20V, V_{DS} = 0V$	-	-	± 100	nA
Gate threshold voltage ⁽³⁾	$V_{GS(th)}$	$V_{DS} = V_{GS}, I_D = 250\mu A$	1	1.5	2.5	V
Drain-source on-resistance ⁽³⁾	$R_{DS(on)}$	$V_{GS} = 10V, I_D = 30A$	-	5.2	5.8	m Ω
		$V_{GS} = 4.5V, I_D = 20A$	-	6.8	9.5	
Dynamic characteristics						
Input Capacitance	C_{iss}	$V_{DS} = 15V, V_{GS} = 0V, f = 1MHz$	-	1950	-	pF
Output Capacitance	C_{oss}		-	320	-	
Reverse Transfer Capacitance	C_{rss}		-	240	-	
Switching characteristics						
Turn-on delay time	$t_{d(on)}$	$V_{DD} = 15V, I_D = 30A,$ $V_{GS} = 10V, R_G = 3\Omega$	-	13	-	ns
Turn-on rise time	t_r		-	36	-	
Turn-off delay time	$t_{d(off)}$		-	43	-	
Turn-off fall time	t_f		-	16	-	
Total Gate Charge	Q_g	$V_{DS} = 15V, I_D = 30A,$ $V_{GS} = 10V$	-	42	-	nC
Gate-Source Charge	Q_{gs}		-	3.9	-	
Gate-Drain Charge	Q_{gd}		-	14	-	
Source-Drain Diode characteristics						
Diode Forward voltage ⁽³⁾	V_{DS}	$V_{GS} = 0V, I_S = 1A$	-	-	1.2	V
Diode Forward current ⁽⁴⁾	I_S		-	-	80	A

Notes:

1. Repetitive Rating: pulse width limited by maximum junction temperature
2. EAS Condition: $T_J = 25^{\circ}\text{C}, V_{DD} = 15V, R_G = 25\Omega, L = 0.5\text{mH}$
3. Pulse Test: pulse width $\leq 300\mu\text{s}$, duty cycle $\leq 2\%$
4. Surface Mounted on FR4 Board, $t \leq 10\text{ sec}$

Test Circuit

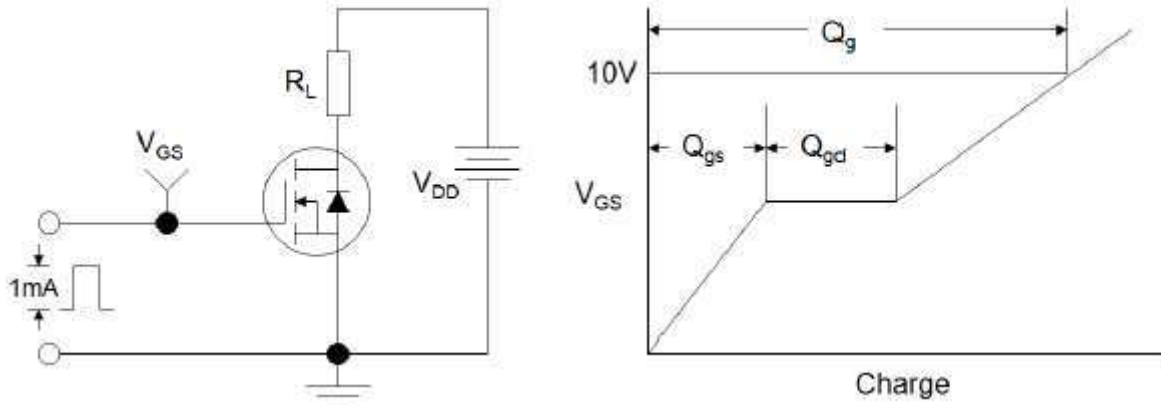

Figure1:Gate Charge Test Circuit & Waveform

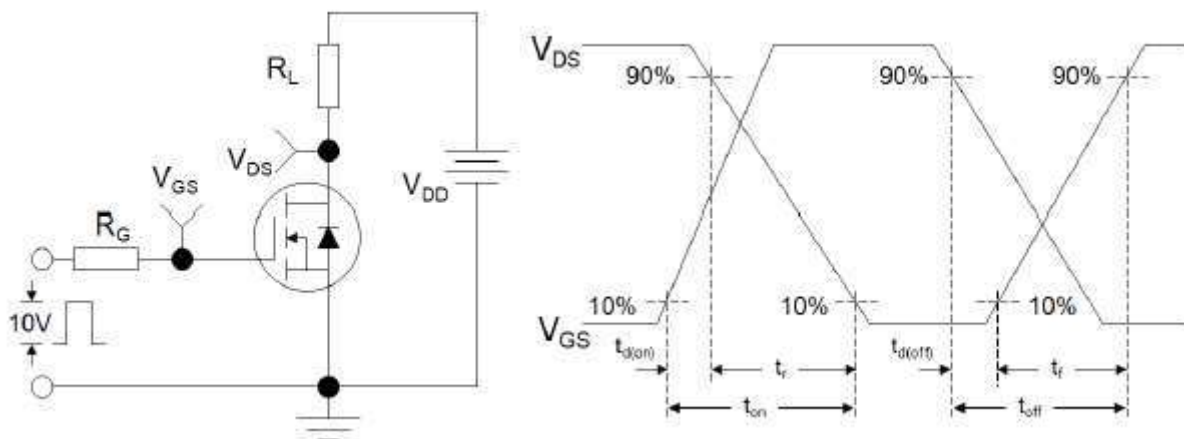

Figure 2: Resistive Switching Test Circuit & Waveforms

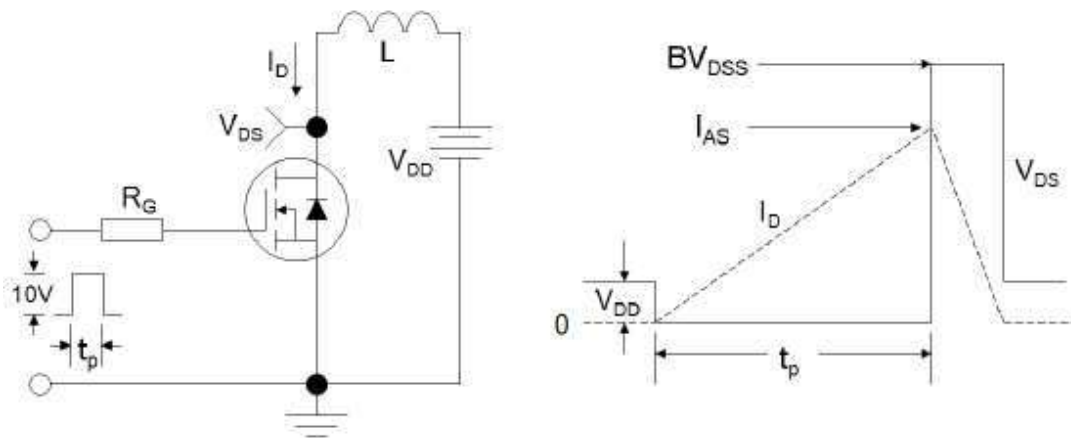

Figure 3:Unclamped Inductive Switching Test Circuit & Waveforms

Typical Performance Characteristics

Figure 1: Output Characteristics

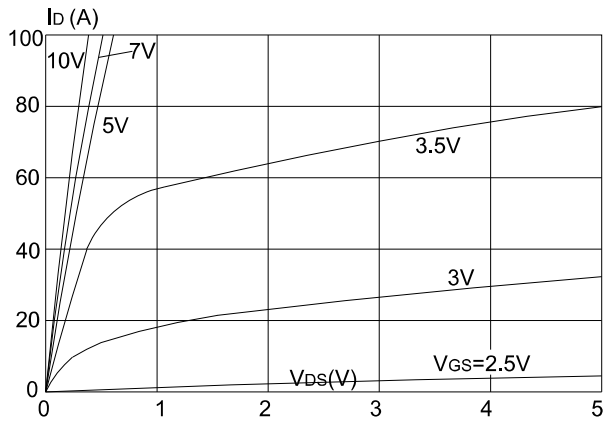

Figure 2: Typical Transfer Characteristics

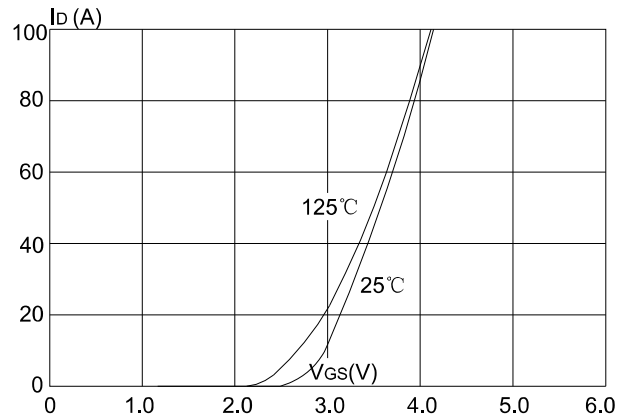

Figure 3: On-resistance vs. Drain Current

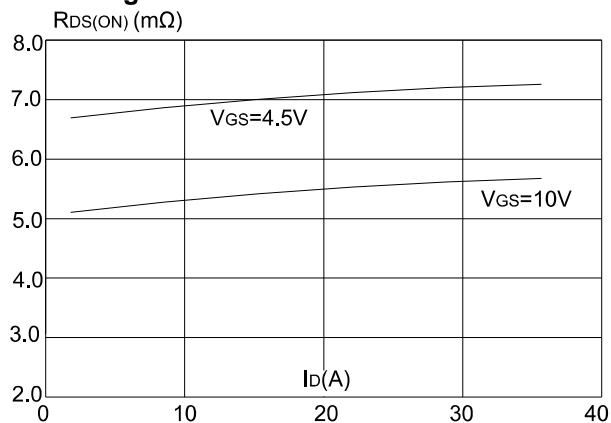

Figure 4: Body Diode Characteristics

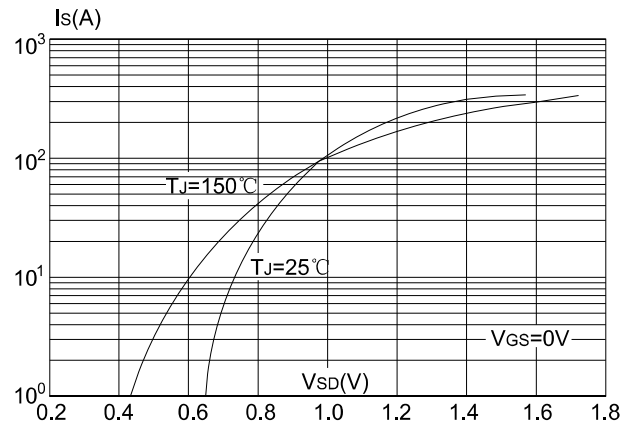

Figure 5: Gate Charge Characteristics

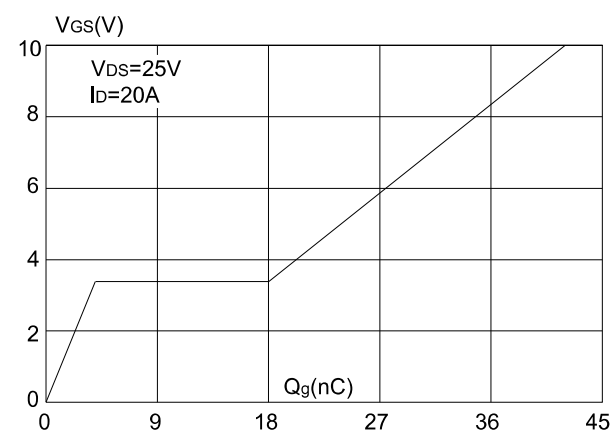

Figure 6: Capacitance Characteristics

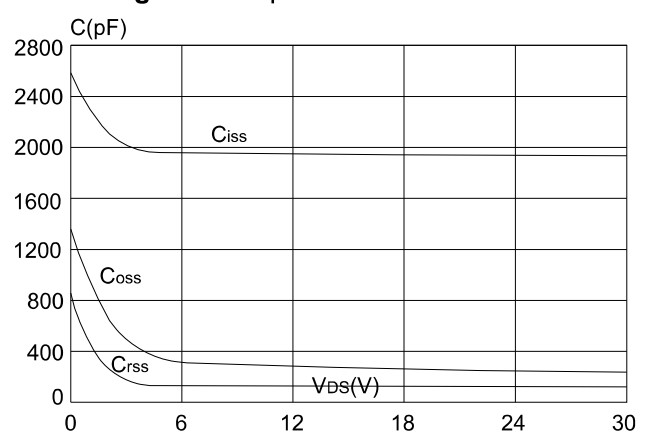

Figure 7: Normalized Breakdown Voltage vs. Junction Temperature

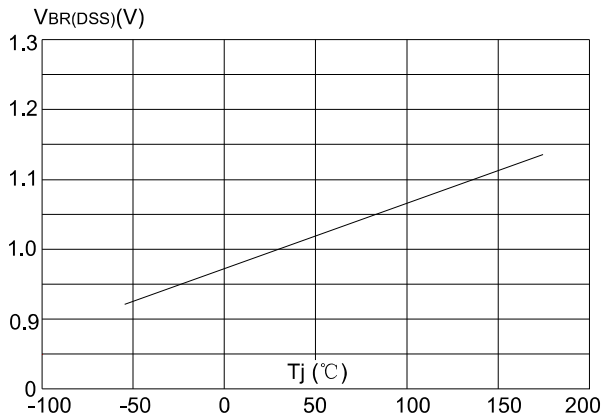

Figure 8: Normalized on Resistance vs. Junction Temperature

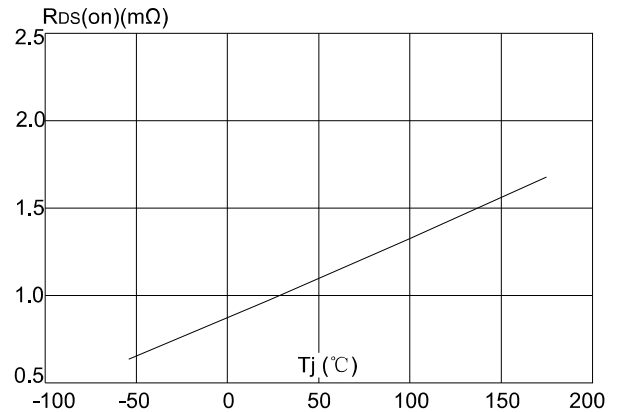

Figure 9: Maximum Safe Operating Area

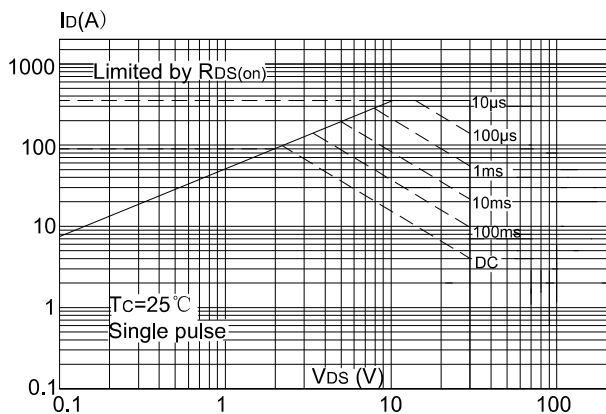

Figure 10: Maximum Continuous Drain Current vs. Case Temperature

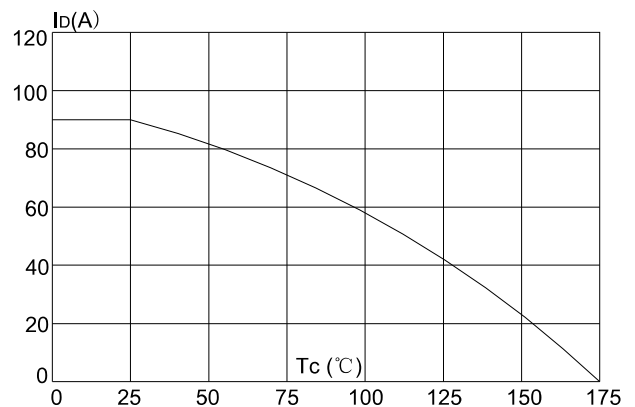
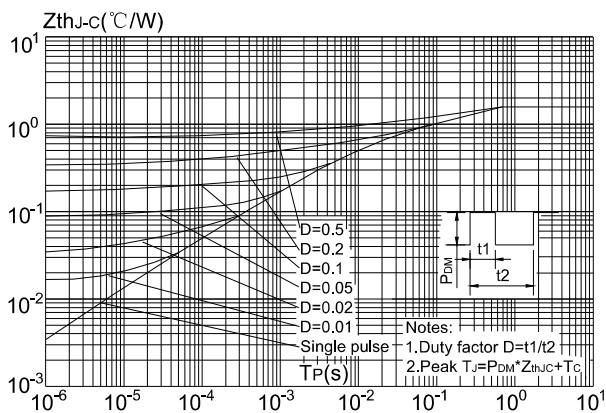
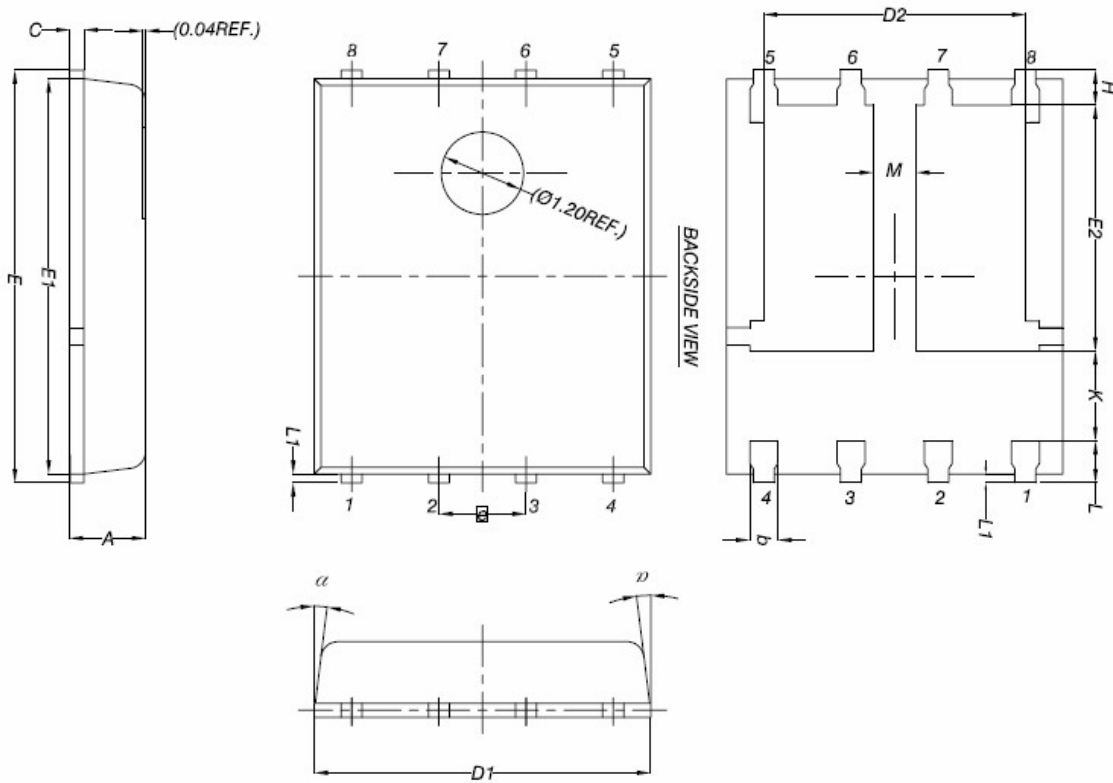

Figure.11: Maximum Effective Transient Thermal Impedance, Junction-to-Case (TO-252)



AP90N03GD
N-Channel Enhancement Mosfet

PDFN5X6-8L Package Information



DIM.	MILLIMETERS		
	MIN.	NOM.	MAX.
A	0.90	1.00	1.10
b	0.33	0.41	0.51
C	0.20	0.25	0.30
D1	4.80	4.90	5.00
D2	3.61	3.81	3.96
E	5.90	6.00	6.10
E1	5.70	5.75	5.80
E2	3.38	3.58	3.78
e	1.27 BSC		
H	0.41	0.51	0.61
K	1.10	-	-
L	0.51	0.61	0.71
L1	0.06	0.13	0.20
M	0.50	-	-
α	0°	-	12°