

AP4018G

N-Channel Power MOSFET

Features

- 40V,100A
 $R_{DS(ON)} < 1.8m\Omega @ V_{GS} = 10V$
 $R_{DS(ON)} < 2.6m\Omega @ V_{GS} = 4.5V$
- Lead free and Green Device Available
- Excellent $R_{DS(ON)}$ and Low Gate Charge
- Lead free product is acquired

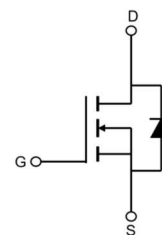

Schematic Diagram

Application

- Load Switch
- PWM Application
- Power management

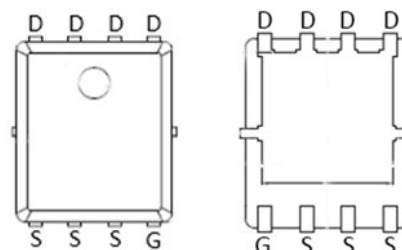

PDFN5X6-8L

Absolute Maximum Ratings ($T_C=25^\circ\text{C}$ unless otherwise specified)

Symbol	Parameter	Max.	Units
V_{DSS}	Drain-Source Voltage	40	V
V_{GSS}	Gate-Source Voltage	± 20	V
I_D	Continuous Drain Current	$T_C = 25^\circ\text{C}$	100
		$T_C = 100^\circ\text{C}$	82
I_{DM}	Pulsed Drain Current ^{note1}	400	A
E_{AS}	Single Pulsed Avalanche Energy ^{note2}	400	mJ
P_D	Power Dissipation	$T_C = 25^\circ\text{C}$	125
$R_{\theta JC}$	Thermal Resistance, Junction to Case	1.0	$^\circ\text{C/W}$
T_J, T_{STG}	Operating and Storage Temperature Range	-55 to +150	$^\circ\text{C}$

AP4018G
N-Channel Power MOSFET
Electrical Characteristics ($T_J=25^{\circ}\text{C}$ unless otherwise specified)

Symbol	Parameter	Test Condition	Min.	Typ.	Max.	Units
Off Characteristic						
$V_{(BR)DSS}$	Drain-Source Breakdown Voltage	$V_{GS}=0V, I_D=250\mu A$	40	-	-	V
I_{DSS}	Zero Gate Voltage Drain Current	$V_{DS}=40V, V_{GS}=0V,$	-	-	1.0	μA
I_{GSS}	Gate to Body Leakage Current	$V_{DS}=0V, V_{GS}=\pm 20V$	-	-	± 100	nA
On Characteristics						
$V_{GS(th)}$	Gate Threshold Voltage	$V_{DS}=V_{GS}, I_D=250\mu A$	1.0	1.6	2.5	V
$R_{DS(on)}$	Static Drain-Source on-Resistance <small>note3</small>	$V_{GS}=10V, I_D=20A$	-	1.5	1.8	m Ω
		$V_{GS}=4.5V, I_D=20A$	-	2.0	2.6	
Dynamic Characteristics						
C_{iss}	Input Capacitance	$V_{DS}=20V, V_{GS}=0V,$ $f=1.0\text{MHz}$	-	3972	-	pF
C_{oss}	Output Capacitance		-	1119	-	pF
C_{rss}	Reverse Transfer Capacitance		-	100	-	pF
Q_g	Total Gate Charge	$V_{DS}=15V, I_D=20A,$ $V_{GS}=4.5V$	-	45	-	nC
Q_{gs}	Gate-Source Charge		-	12	-	nC
Q_{gd}	Gate-Drain("Miller") Charge		-	18.5	-	nC
Switching Characteristics						
$t_{d(on)}$	Turn-on Delay Time	$V_{DD}=15V, I_D=20A,$ $R_L=1\Omega, R_{GEN}=3\Omega,$ $V_{GS}=10V$	-	18.5	-	ns
t_r	Turn-on Rise Time		-	9	-	ns
$t_{d(off)}$	Turn-off Delay Time		-	58	-	ns
t_f	Turn-off Fall Time		-	32	-	ns
Drain-Source Diode Characteristics and Maximum Ratings						
I_S	Maximum Continuous Drain to Source Diode Forward Current		-	-	100	A
I_{SM}	Maximum Pulsed Drain to Source Diode Forward Current		-	-	400	A
V_{SD}	Drain to Source Diode Forward Voltage	$V_{GS}=0V, I_S=10A$	-	-	1.2	V

- Notes: 1. Repetitive Rating: Pulse Width Limited by Maximum Junction Temperature
 2. EAS condition: $T_J=25^{\circ}\text{C}$, $V_{DD}=25V$, $R_G=25\Omega$, $L=0.5\text{mH}$, $I_{AS}=40A$
 3. Pulse Test: Pulse Width $\leq 300\mu s$, Duty Cycle $\leq 0.5\%$

N-Channel Power MOSFET

Typical Characteristics

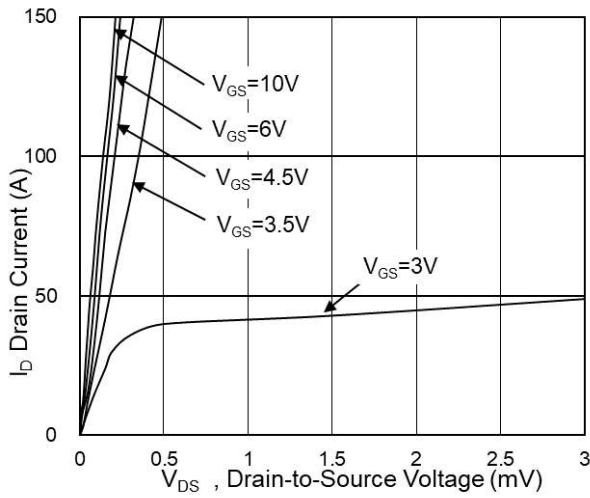

Fig.1 Typical Output Characteristics

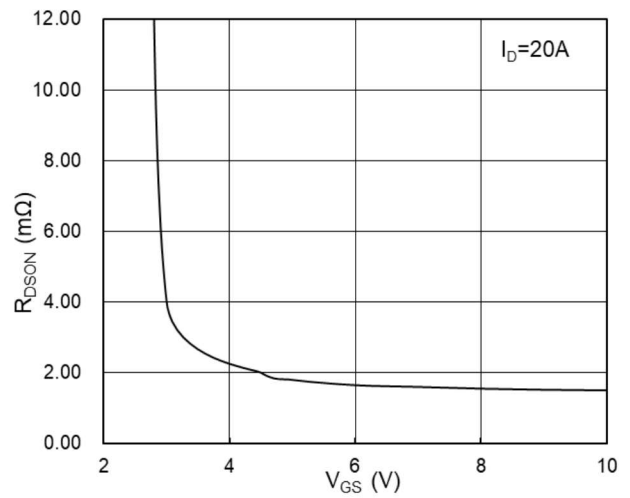

Fig.2 On-Resistance vs G-S Voltage

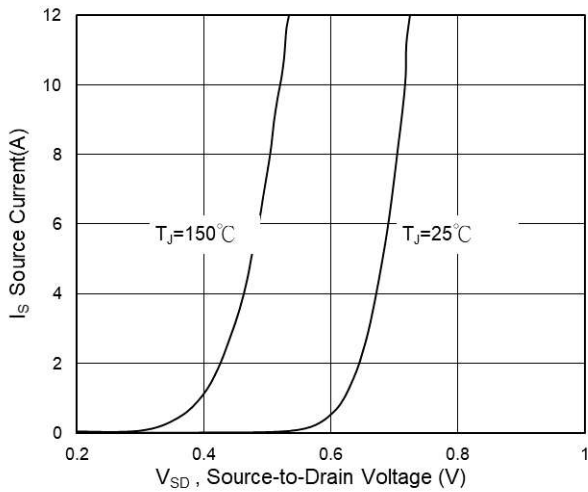

Fig.3 Source Drain Forward Characteristics

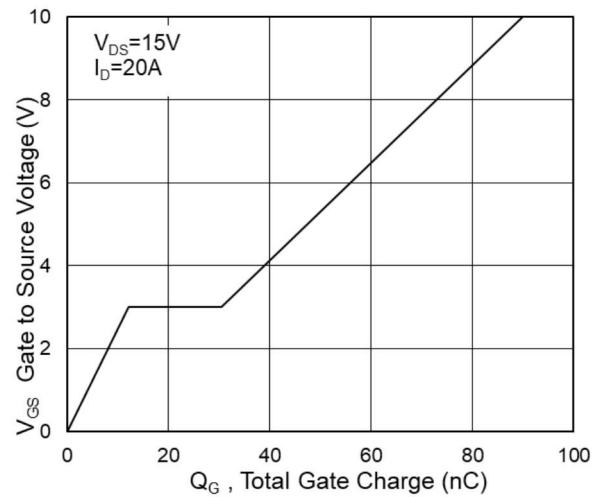

Fig.4 Gate-Charge Characteristics

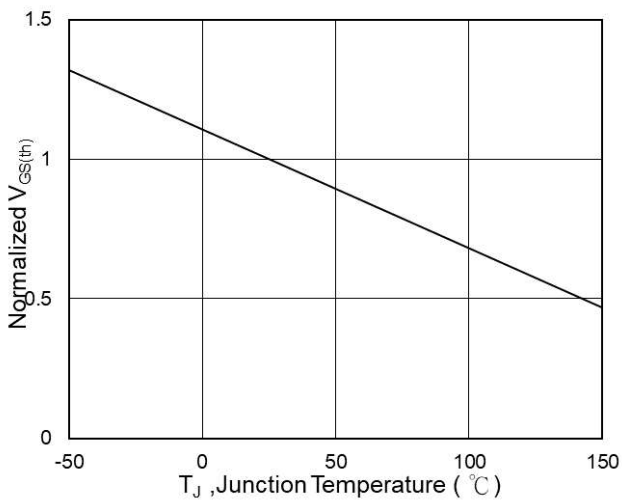

Fig.5 Normalized $V_{GS(th)}$ vs T_J

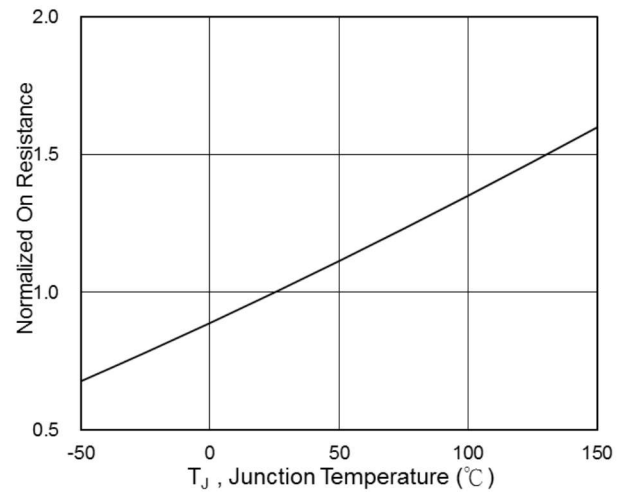

Fig.6 Normalized $R_{DS(on)}$ vs T_J

AP4018G

N-Channel Power MOSFET

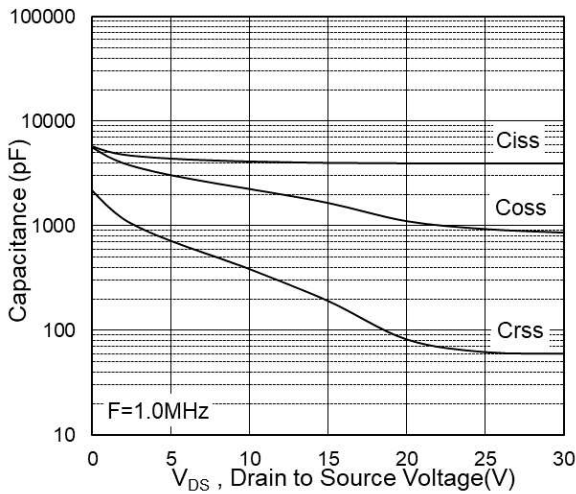

Fig.7 Capacitance

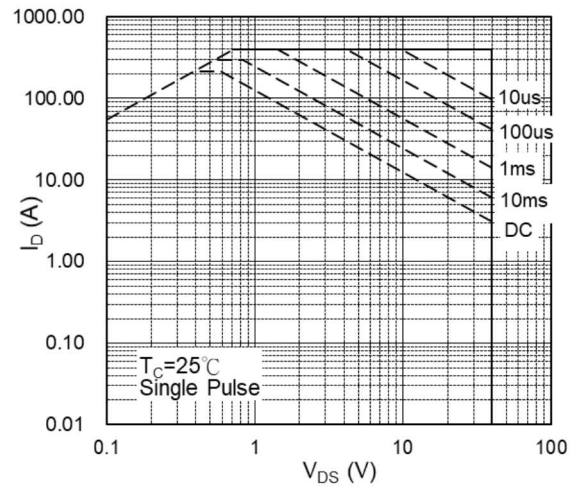

Fig.8 Safe Operating Area

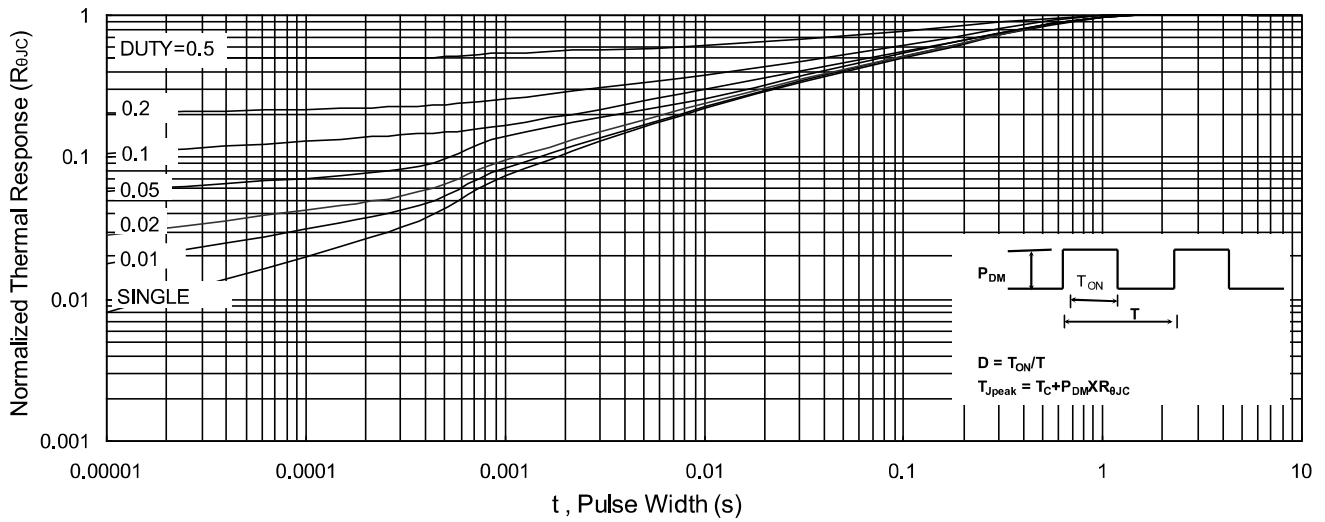

Fig.9 Normalized Maximum Transient Thermal Impedance

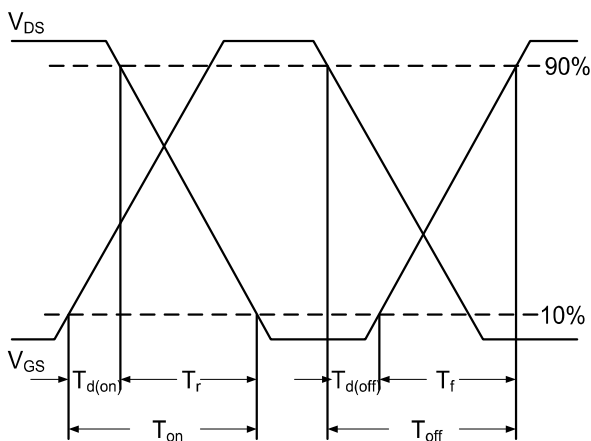

Fig.10 Switching Time Waveform

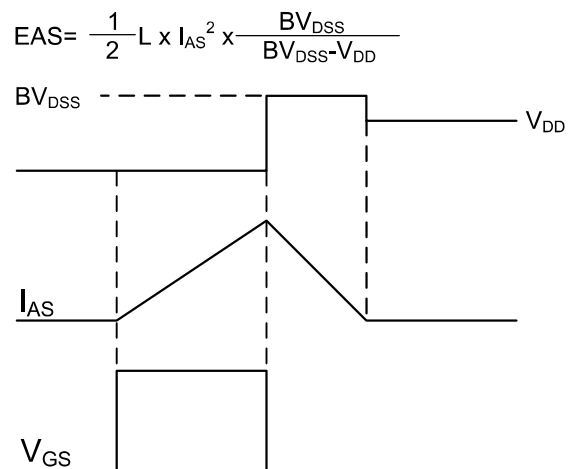

Fig.11 Unclamped Inductive Switching Waveform

AP4018G

N-Channel Power MOSFET

Test Circuit

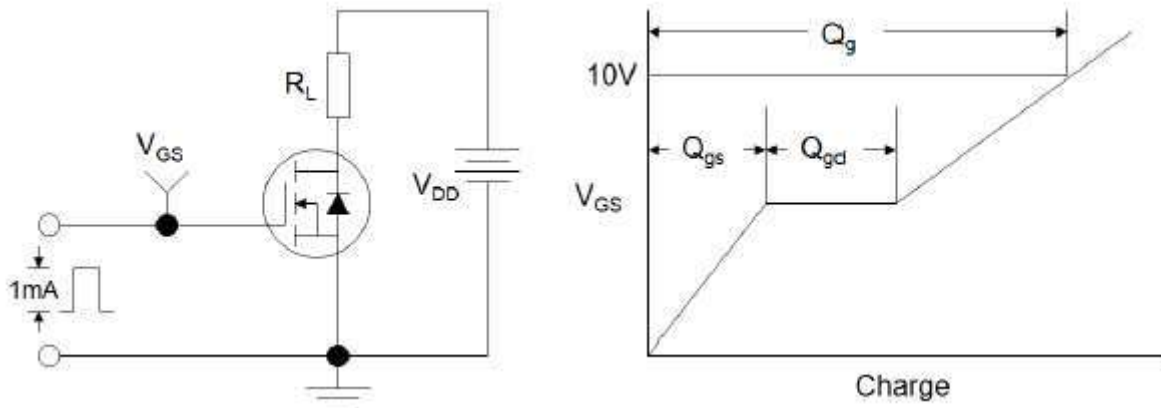

Figure 1: Gate Charge Test Circuit & Waveform

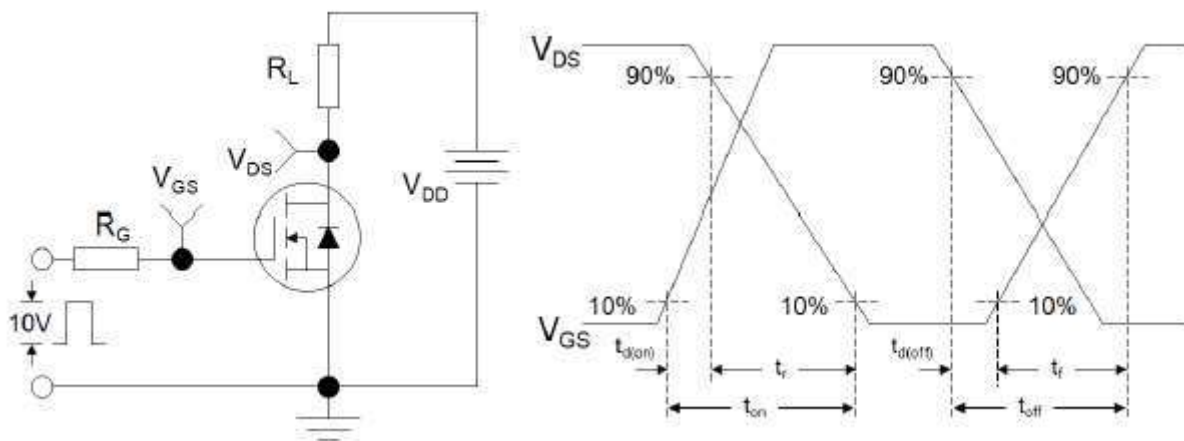

Figure 2: Resistive Switching Test Circuit & Waveforms

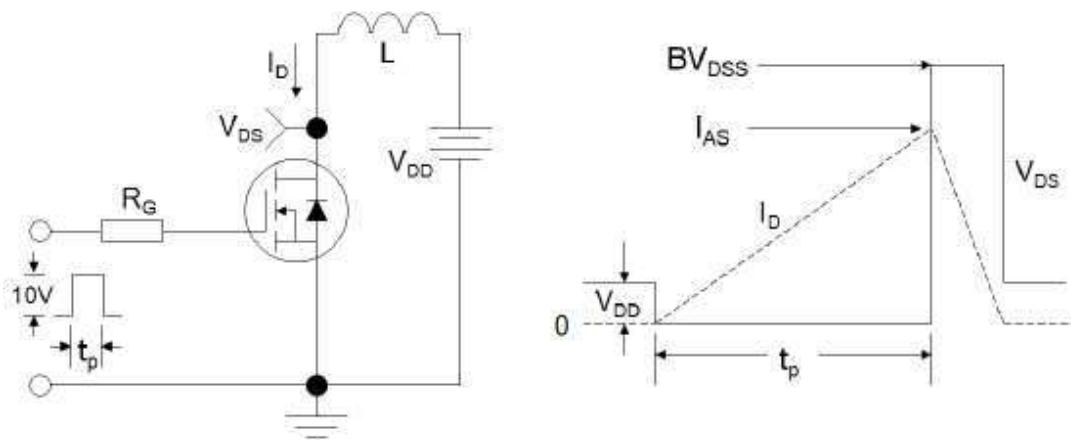
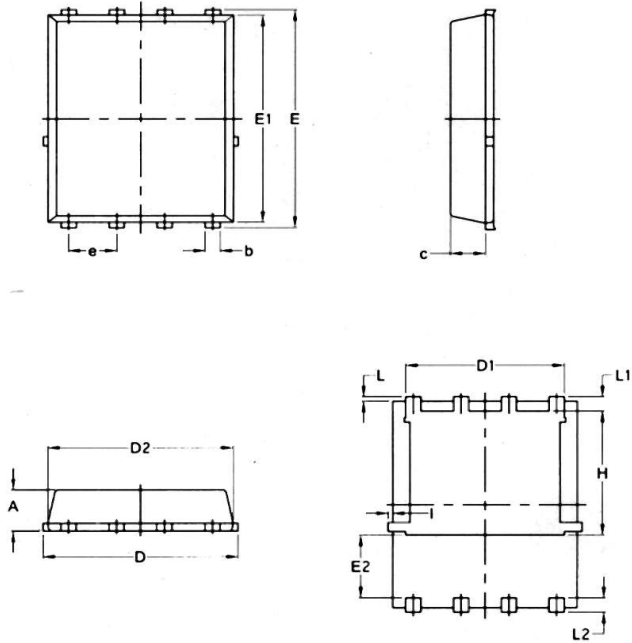

Figure 3: Unclamped Inductive Switching Test Circuit & Waveforms

AP4018G

N-Channel Power MOSFET

Package Mechanical Data



PDFN5X6-8L

SYMBOL	COMMON			
	MM		INCH	
	MIN.	MAX.	MIN.	MAX.
A	1.03	1.17	0.0406	0.0461
b	0.34	0.48	0.0134	0.0189
c	0.824	0.970	0.0324	0.0382
D	4.80	5.40	0.1890	0.2126
D1	4.11	4.31	0.1618	0.1697
D2	4.80	5.00	0.1890	0.1969
E	5.95	6.15	0.2343	0.2421
E1	5.65	5.85	0.2224	0.2303
E2	1.60	—	0.0630	—
e	1.27 BSC		0.05 BSC	
L	0.05	0.25	0.0020	0.0098
L1	0.38	0.50	0.0150	0.0197
L2	0.38	0.50	0.0150	0.0197
H	3.30	3.50	0.1299	0.1378
I	—	0.18	—	0.0070

AP4018G**N-Channel Power MOSFET**

Information furnished in this document is believed to be accurate and reliable. However, Shenzhen All Power Semiconductor Co.,Ltd assumes no responsibility for the consequences of use without consideration for such information nor use beyond it.

Information mentioned in this document is subject to change without notice, apart from that when an agreement is signed, All Power complies with the agreement.

Products and information provided in this document have no infringement of patents. All Power assumes no responsibility for any infringement of other rights of third parties which may result from the use of such products and information.

This document supersedes and replaces all information previously supplied.