

**N-Channel Power MOSFET**

**Description**

The AP4846 uses advanced trench technology and design to provide excellent  $R_{DS(ON)}$  with low gate charge. It can be used in a wide variety of applications.

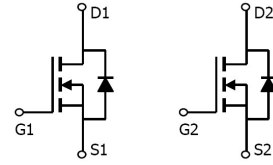

Schematic diagram

**General Features**

- $V_{DS} = 60V, I_D = 7A$   
 $R_{DS(ON)} < 20m\Omega @ V_{GS}=10V$  (Typ:15m $\Omega$ )  
 $R_{DS(ON)} < 25m\Omega @ V_{GS}=4.5V$  (Typ:19.5m $\Omega$ )
- High density cell design for ultra low  $R_{dson}$
- Fully characterized avalanche voltage and current
- Low gate to drain charge to reduce switching losses

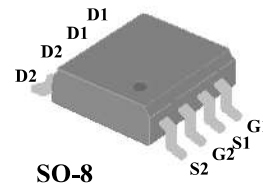

pin assignment

**Application**

- Power switching application
- Load switch

**Package Marking and Ordering Information**

Device Marking	Device	Device Package	Reel Size	Tape width	Quantity
4846	AP4846	SOP-8			

**Absolute Maximum Ratings ( $T_C=25^\circ C$  unless otherwise noted)**

Parameter	Symbol	Limit	Unit
Drain-Source Voltage	$V_{DS}$	60	V
Gate-Source Voltage	$V_{GS}$	$\pm 20$	V
Drain Current-Continuous	$I_D$	7	A
Drain Current-Continuous( $T_C=100^\circ C$ )	$I_D(100^\circ C)$	5.4	A
Pulsed Drain Current	$I_{DM}$	32	A
Maximum Power Dissipation	$P_D$	1.5	W
Operating Junction and Storage Temperature Range	$T_J, T_{STG}$	-55 To 150	$^\circ C$

**Thermal Characteristic**

Thermal Resistance, Junction-to-Ambient <sup>(Note 2)</sup>	$R_{\theta JA}$	85	$^\circ C/W$
---	-----------------	----	--------------

**AP4846**
**N-Channel Power MOSFET**
**Electrical Characteristics (TC=25°C unless otherwise noted)**

Parameter	Symbol	Condition	Min	Typ	Max	Unit
<b>Off Characteristics</b>						
Drain-Source Breakdown Voltage	$BV_{DSS}$	$V_{GS}=0V, I_D=250\mu A$	60		-	V
Zero Gate Voltage Drain Current	$I_{DSS}$	$V_{DS}=60V, V_{GS}=0V$	-	-	1	$\mu A$
Gate-Body Leakage Current	$I_{GSS}$	$V_{GS}=\pm 20V, V_{DS}=0V$	-	-	$\pm 100$	nA
<b>On Characteristics</b> (Note 3)						
Gate Threshold Voltage	$V_{GS(th)}$	$V_{DS}=V_{GS}, I_D=250\mu A$	1.2	1.8	2.2	V
Drain-Source On-State Resistance	$R_{DS(ON)}$	$V_{GS}=10V, I_D=7A$	-	15	20	m $\Omega$
		$V_{GS}=4.5V, I_D=5A$	-	19.5	25	m $\Omega$
Forward Transconductance	$g_{FS}$	$V_{DS}=5V, I_D=9A$	25	-	-	S
<b>Dynamic Characteristics</b> (Note 4)						
Input Capacitance	$C_{iss}$	$V_{DS}=30V, V_{GS}=0V,$ $F=1.0MHz$	-	2180	-	PF
Output Capacitance	$C_{oss}$		-	350	-	PF
Reverse Transfer Capacitance	$C_{rss}$		-	270	-	PF
<b>Switching Characteristics</b> (Note 4)						
Turn-on Delay Time	$t_{d(on)}$	$V_{DD}=30V, R_L=1\Omega$ $V_{GS}=10V, R_{GEN}=3\Omega$	-	8.5	-	nS
Turn-on Rise Time	$t_r$		-	6	-	nS
Turn-Off Delay Time	$t_{d(off)}$		-	30	-	nS
Turn-Off Fall Time	$t_f$		-	5	-	nS
Total Gate Charge	$Q_g$	$V_{DS}=30V, I_D=8A,$ $V_{GS}=10V$	-	58	-	nC
Gate-Source Charge	$Q_{gs}$		-	8	-	nC
Gate-Drain Charge	$Q_{gd}$		-	17	-	nC
<b>Drain-Source Diode Characteristics</b>						
Diode Forward Voltage	$V_{SD}$	$V_{GS}=0V, I_S=9A$	-	-	1.2	V
Diode Forward Current	$I_S$	-	-	-	7	A
Reverse Recovery Time	$t_{rr}$	$T_J = 25^\circ C, I_F=9A$	-	30	-	nS
Reverse Recovery Charge	$Q_{rr}$	$di/dt = 100A/\mu s$ (Note 3)	-	44	-	nC

**Notes:**

1. Repetitive Rating: Pulse width limited by maximum junction temperature.
2. Surface Mounted on FR4 Board,  $t \leq 10$  sec.
3. Pulse Test: Pulse Width  $\leq 300\mu s$ , Duty Cycle  $\leq 2\%$ .
4. Guaranteed by design, not subject to production

# AP4846

## N-Channel Power MOSFET

### Test Circuit

#### 1) $E_{AS}$ test Circuit

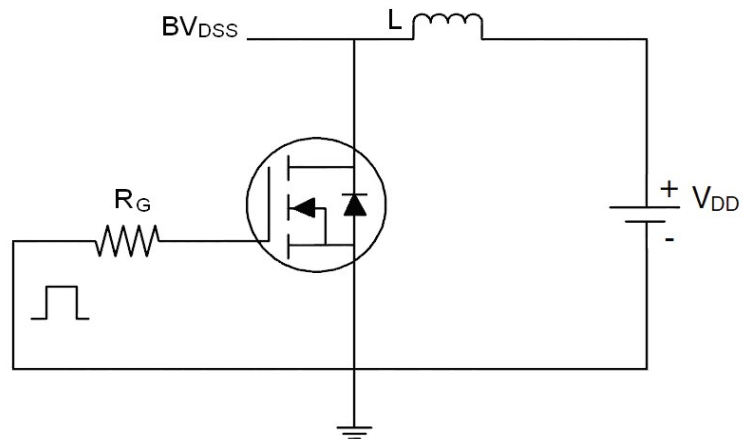

#### 2) Gate charge test Circuit

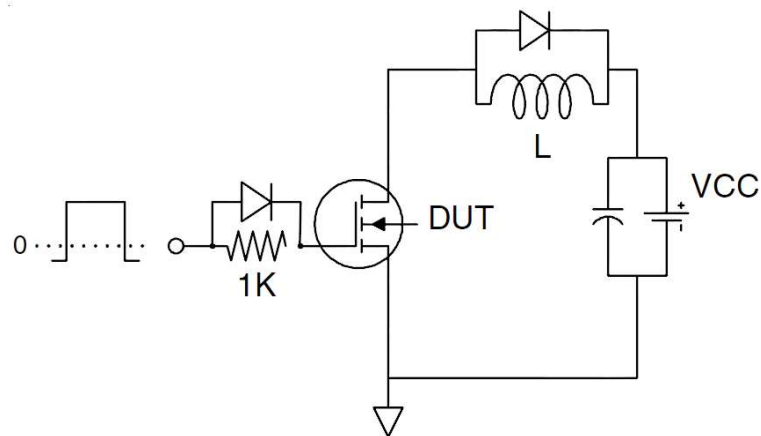

#### 3) Switch Time Test Circuit

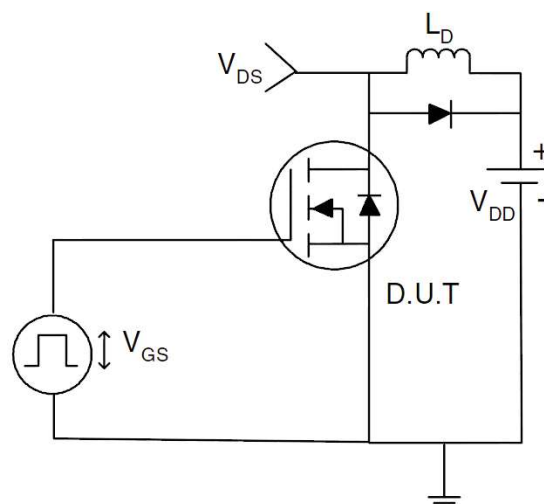

**RATING AND CHARACTERISTICS CURVES**

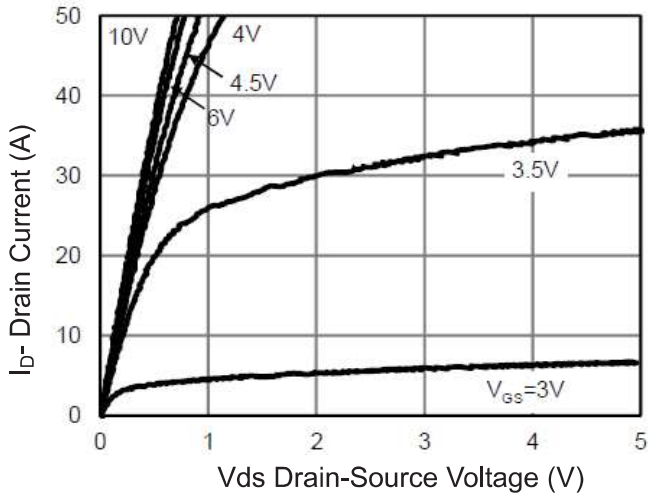

**Figure 1 Output Characteristics**

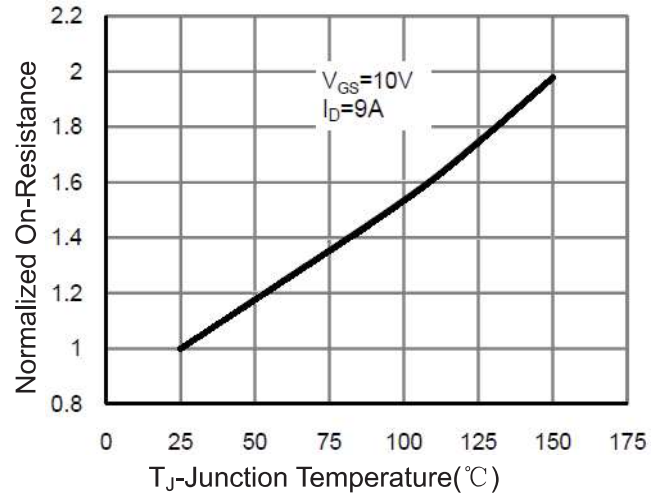

**Figure 4 Rdson-Junction Temperature**

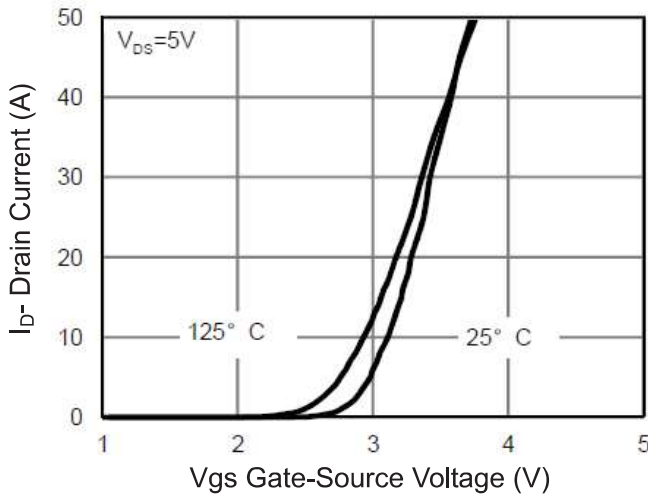

**Figure 2 Transfer Characteristics**

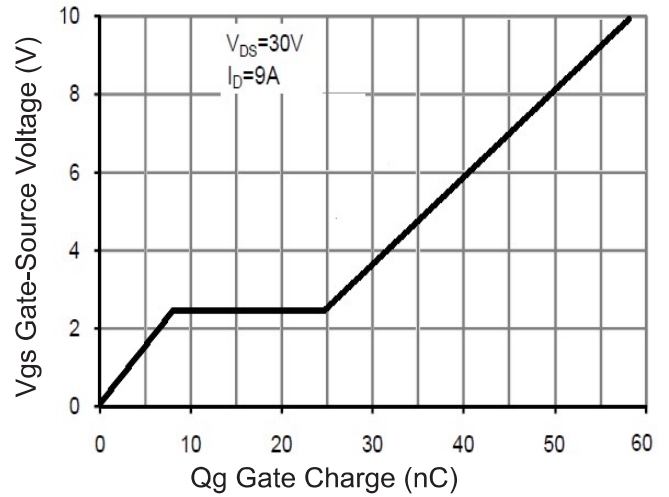

**Figure 5 Gate Charge**

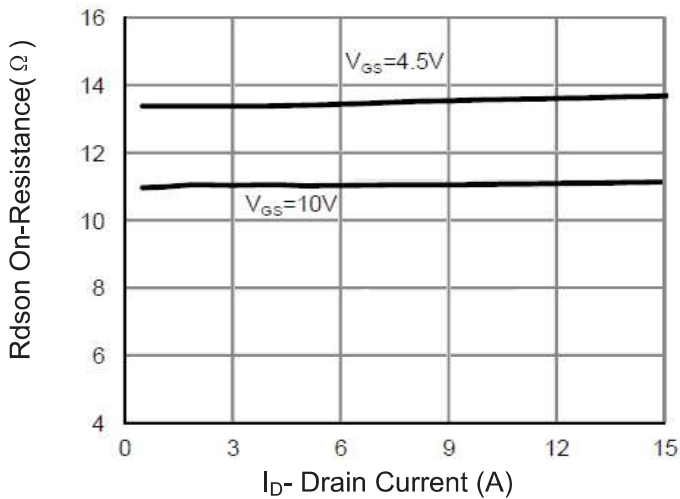

**Figure 3 Rdson- Drain Current**

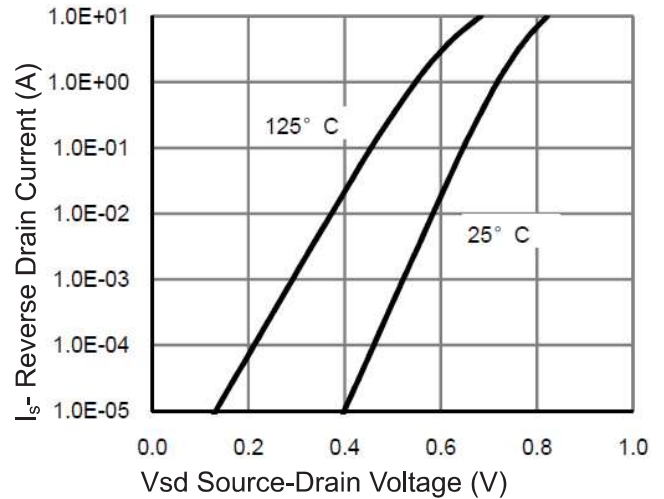

**Figure 6 Source- Drain Diode Forward**

**AP4846**

**N-Channel Power MOSFET**

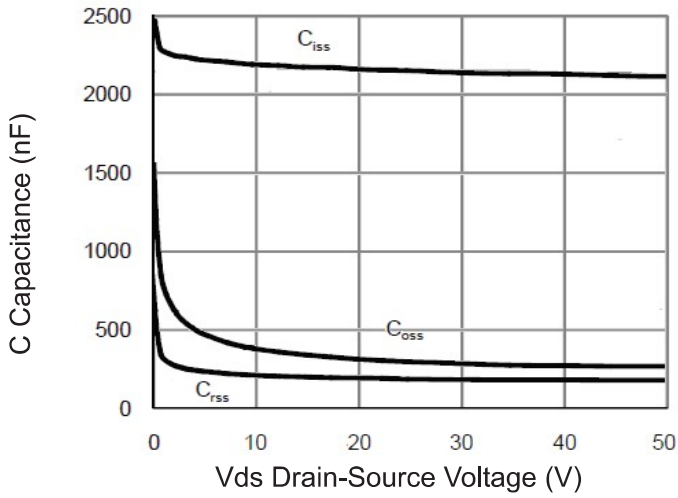

**Figure 7 Capacitance vs Vds**

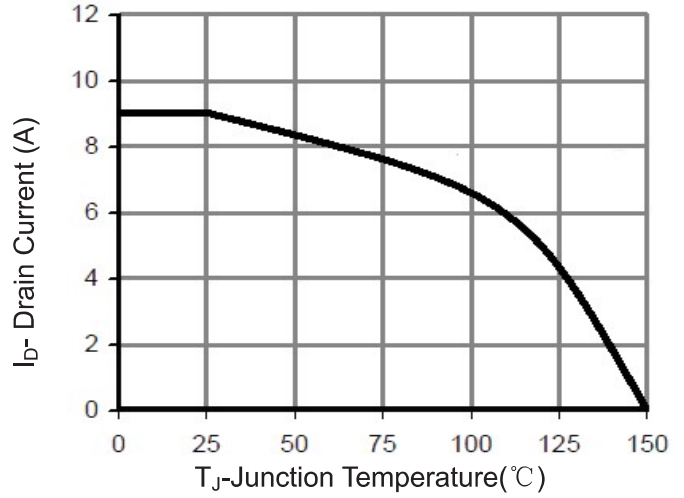

**Figure 9 Current De-rating**

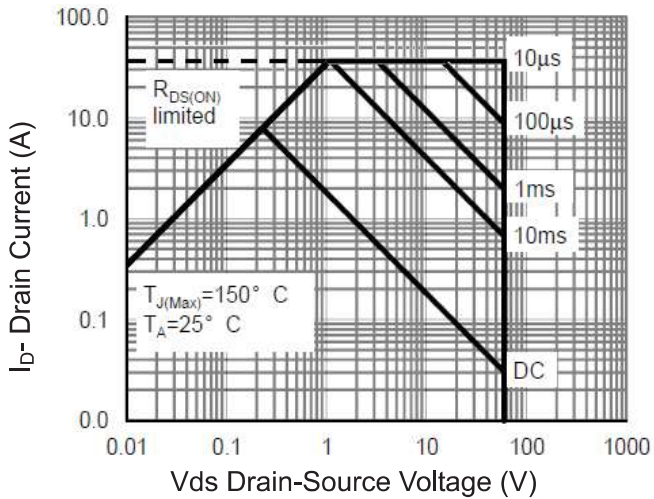

**Figure 8 Safe Operation Area**

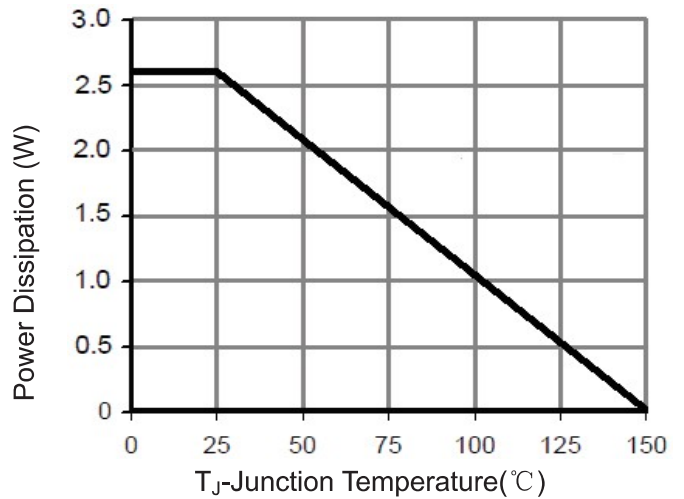

**Figure 10 Power De-rating**

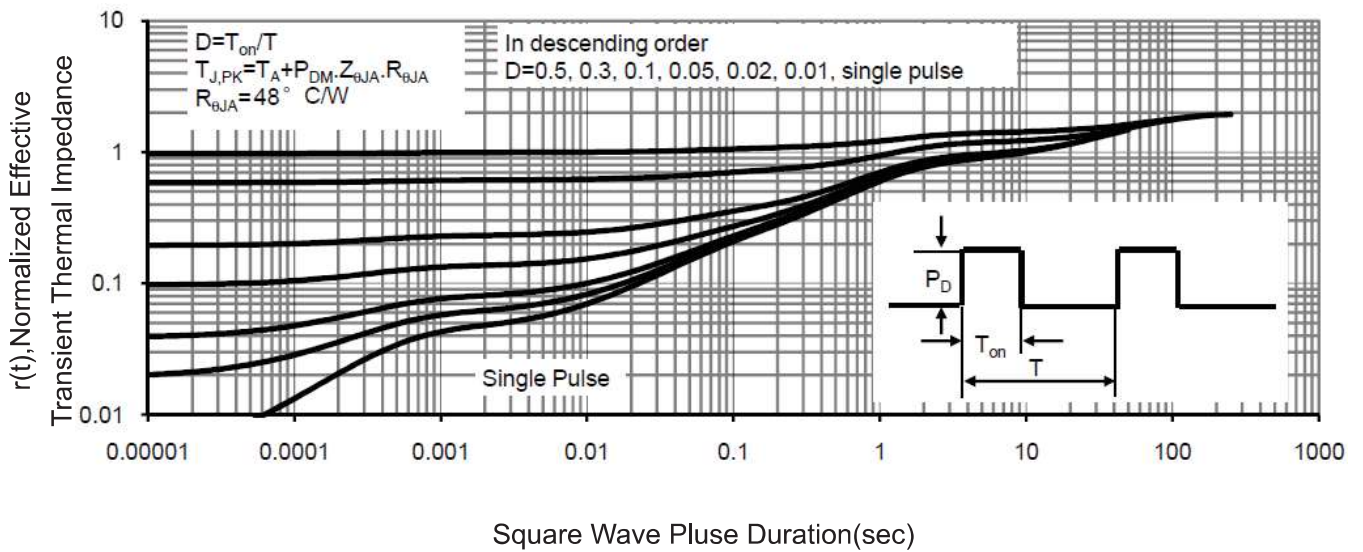
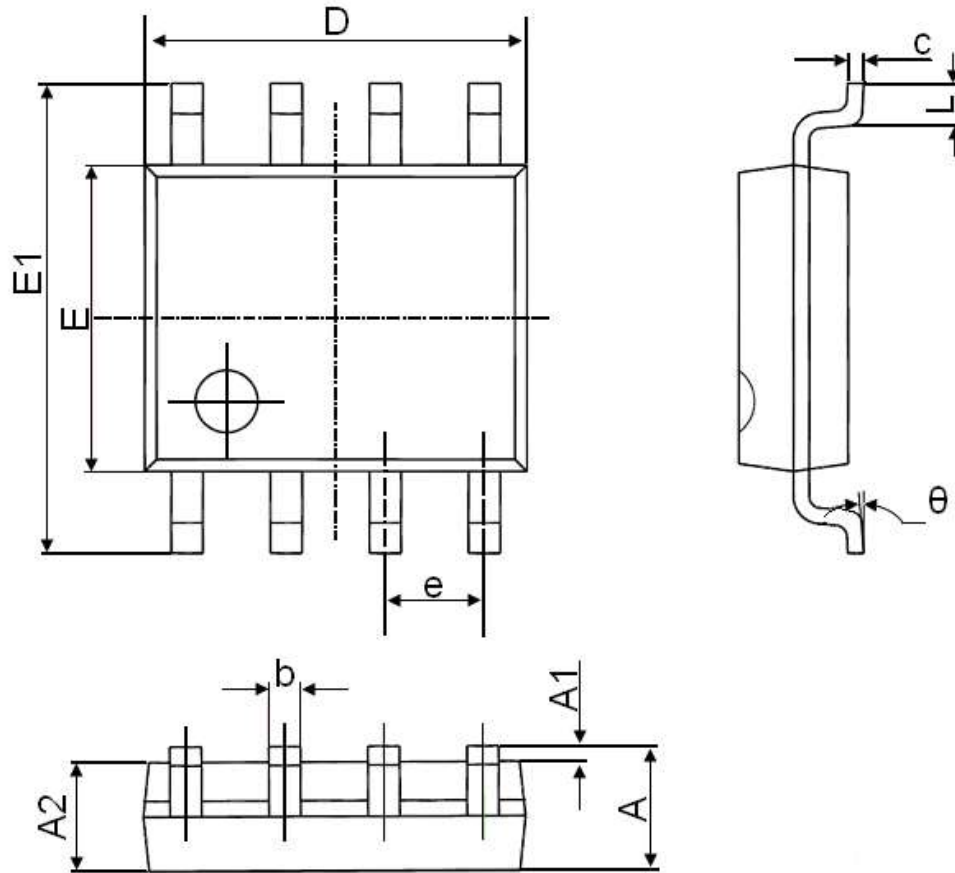

**Figure 11 Normalized Maximum Transient Thermal Impedance**

**AP4846**

**N-Channel Power MOSFET**

**SOP-8 Package Information**



Symbol	Dimensions In Millimeters		Dimensions In Inches	
	Min.	Max.	Min.	Max.
A	1.350	1.750	0.053	0.069
A1	0.100	0.250	0.004	0.010
A2	1.350	1.550	0.053	0.061
b	0.330	0.510	0.013	0.020
c	0.170	0.250	0.006	0.010
D	4.700	5.100	0.185	0.200
E	3.800	4.000	0.150	0.157
E1	5.800	6.200	0.228	0.244
e	1.270(BSC)		0.050(BSC)	
L	0.400	1.270	0.016	0.050
theta	0°	8°	0°	8°