

# AP2012

## N-Channel Power MOSFET

### Description

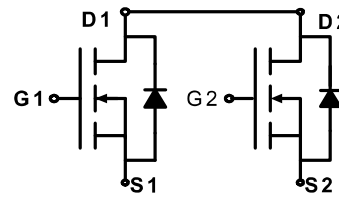
The AP2012 uses advanced trench technology to provide excellent  $R_{DS(ON)}$ , low gate charge and operation with gate voltages as low as 1.8V. This device is suitable for use as a load switch or in PWM applications .

### General Features

- $V_{DS} = 20V, I_D = 12A$   
 $R_{DS(ON)} < 11m\Omega @ V_{GS}=4.5V$   
 $R_{DS(ON)} < 14m\Omega @ V_{GS}=2.5V$
- High power and current handling capability
- Lead free product is acquired
- Surface mount package

### Application

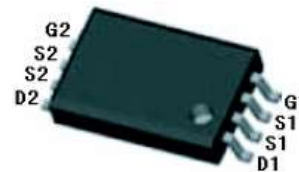
- Uni-directional load switch
- Bi-directional load switch



Schematic diagram



Marking and pin assignment



TSSOP-8 top view

### Absolute Maximum Ratings ( $T_A=25^\circ C$ unless otherwise noted)

Parameter	Symbol	Limit	Unit
Drain-Source Voltage	$V_{DS}$	20	V
Gate-Source Voltage	$V_{GS}$	$\pm 12$	V
Drain Current-Continuous	$I_D$	12	A
Drain Current-Pulsed <sup>(Note 1)</sup>	$I_{DM}$	45	A
Maximum Power Dissipation	$P_D$	2	W
Operating Junction and Storage Temperature Range	$T_J, T_{STG}$	-55 To 150	$^\circ C$

### Thermal Characteristic

Thermal Resistance, Junction-to-Ambient <sup>(Note 2)</sup>	$R_{\theta JA}$	62.5	$^\circ C/W$
---	-----------------	------	--------------

### Electrical Characteristics ( $T_A=25^\circ C$ unless otherwise noted)

Parameter	Symbol	Condition	Min	Typ	Max	Unit
<b>Off Characteristics</b>						
Drain-Source Breakdown Voltage	$BV_{DSS}$	$V_{GS}=0V, I_D=250\mu A$	20			V
Zero Gate Voltage Drain Current	$I_{DSS}$	$V_{DS}=20V, V_{GS}=0V$	-	-	1	$\mu A$

**AP2012**
**N-Channel Power MOSFET**

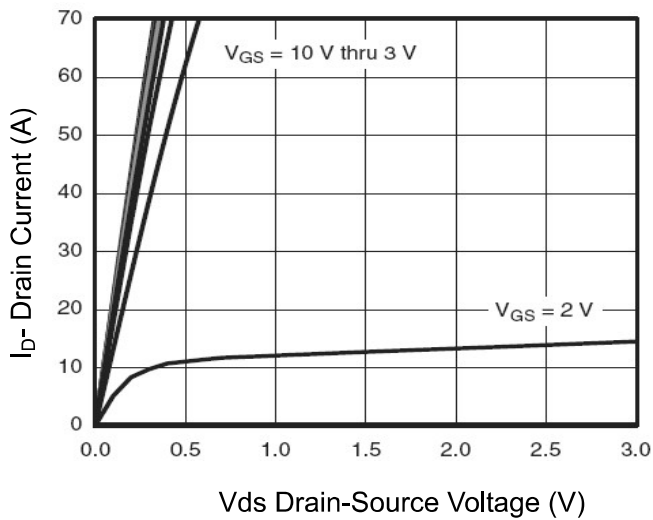
Parameter	Symbol	Condition	Min	Typ	Max	Unit
Gate-Body Leakage Current	$I_{GSS}$	$V_{GS}=\pm 10V, V_{DS}=0V$	-	-	$\pm 100$	nA
<b>On Characteristics</b> (Note 3)						
Gate Threshold Voltage	$V_{GS(th)}$	$V_{DS}=V_{GS}, I_D=250\mu A$	0.5	0.7	1.0	V
Drain-Source On-State Resistance	$R_{DS(on)}$	$V_{GS}=4.5V, I_D=5A$	-	9.5	11	m $\Omega$
		$V_{GS}=2.5V, I_D=4A$	-	12.5	14	m $\Omega$
Forward Transconductance	$g_{FS}$	$V_{DS}=5V, I_D=8A$	-	15	-	S
<b>Dynamic Characteristics</b> (Note4)						
Input Capacitance	$C_{iss}$	$V_{DS}=10V, V_{GS}=0V,$ $F=1.0MHz$	-	1800	-	PF
Output Capacitance	$C_{oss}$		-	230	-	PF
Reverse Transfer Capacitance	$C_{rss}$		-	200	-	PF
<b>Switching Characteristics</b> (Note 4)						
Turn-on Delay Time	$t_{d(on)}$	$V_{DD}=10V, R_L=1.2\Omega$ $V_{GS}=10V, R_{GEN}=3\Omega$	-	2.5		nS
Turn-on Rise Time	$t_r$		-	7.2		nS
Turn-Off Delay Time	$t_{d(off)}$		-	49		nS
Turn-Off Fall Time	$t_f$		-	10.8		nS
Total Gate Charge	$Q_g$	$V_{DS}=10V, I_D=8A,$ $V_{GS}=4.5V$	-	17.9		nC
Gate-Source Charge	$Q_{gs}$		-	1.5	-	nC
Gate-Drain Charge	$Q_{gd}$		-	4.7	-	nC
<b>Drain-Source Diode Characteristics</b>						
Diode Forward Voltage (Note 3)	$V_{SD}$	$V_{GS}=0V, I_S=1A$	-	-	1.2	V
Diode Forward Current (Note 2)	$I_S$		-	-	12	A

**Notes:**

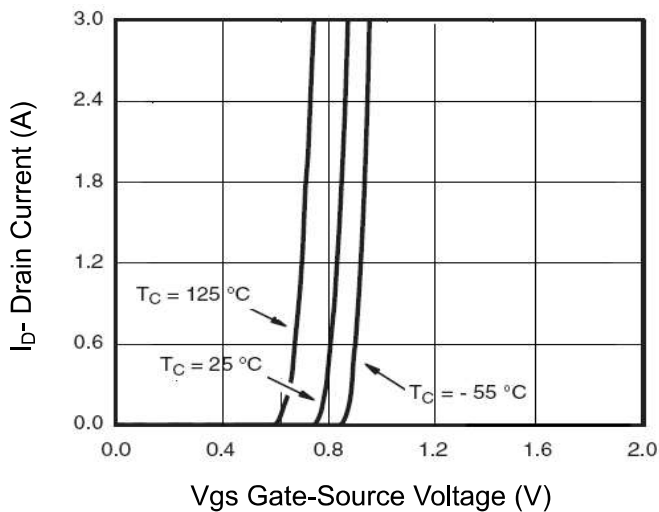
1. Repetitive Rating: Pulse width limited by maximum junction temperature.
2. Surface Mounted on FR4 Board,  $t \leq 10$  sec.
3. Pulse Test: Pulse Width  $\leq 300\mu s$ , Duty Cycle  $\leq 2\%$ .
4. Guaranteed by design, not subject to production

**N-Channel Power MOSFET**

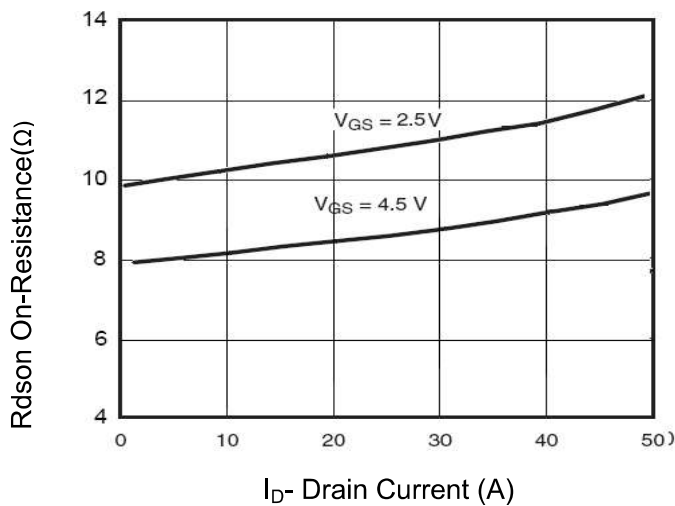
**Typical Electrical and Thermal Characteristics**



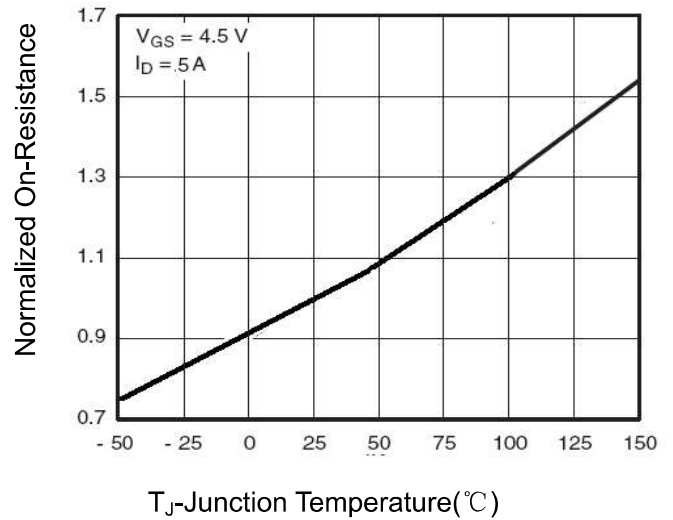
**Figure 1 Output Characteristics**



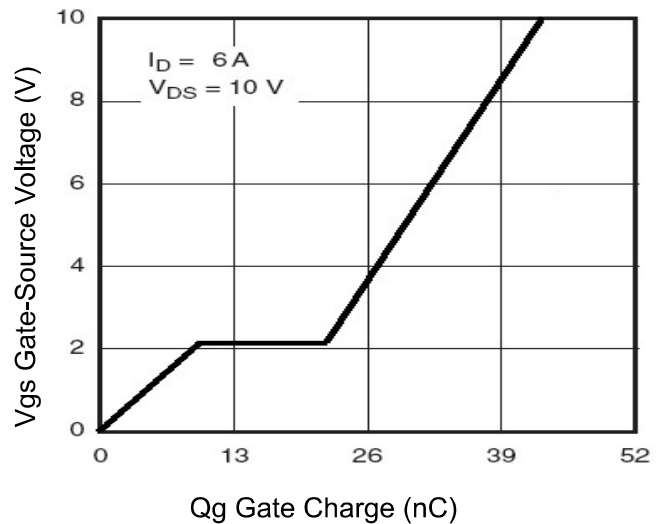
**Figure 3 Transfer Characteristics**



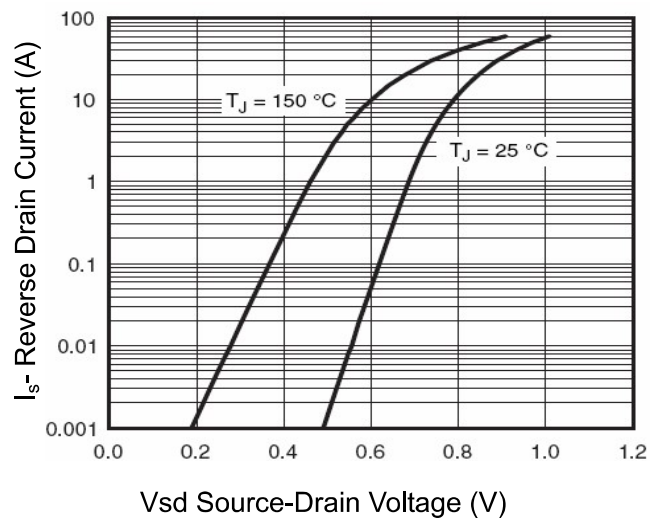
**Figure 5 Rdson- Drain Current**



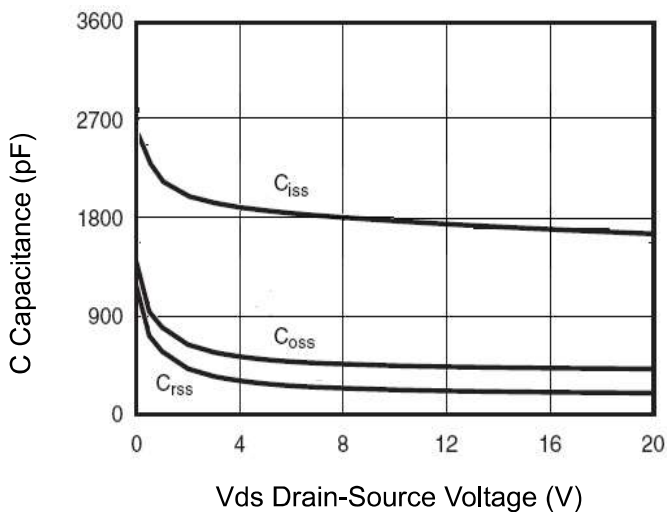
**Figure 2 Rdson-Junction Temperature**



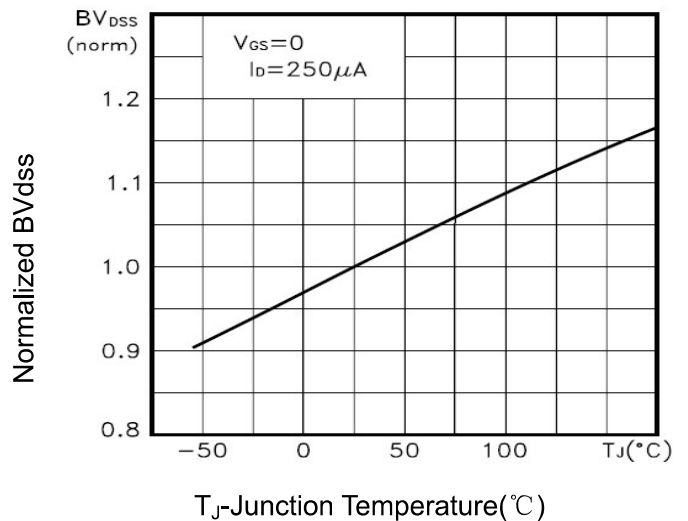
**Figure 4 Gate Charge**



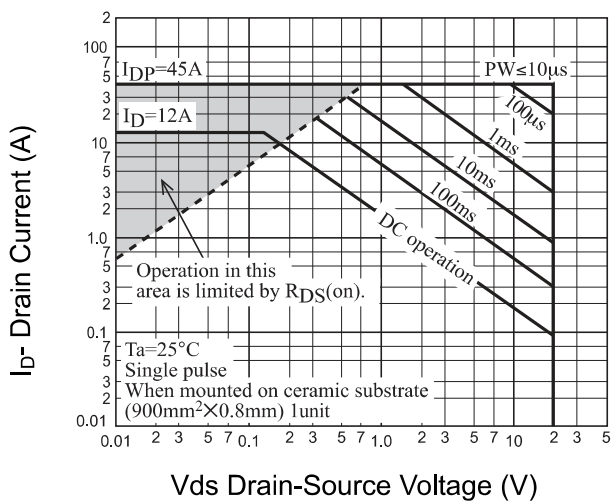
**Figure 6 Source- Drain Diode Forward**



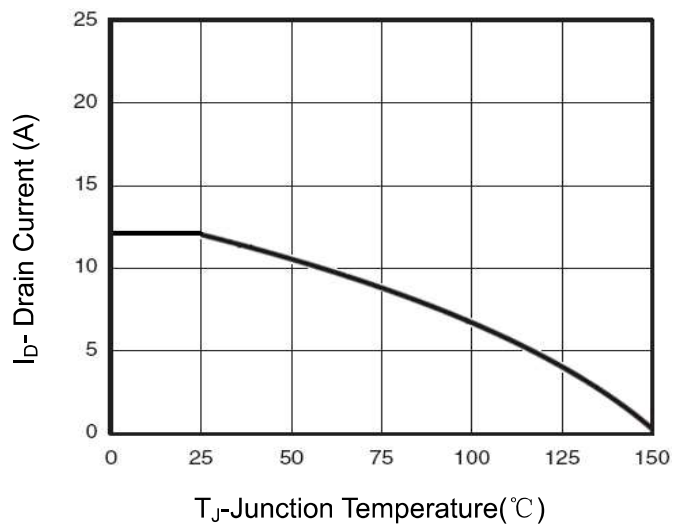
**Figure 7 Capacitance vs Vds**



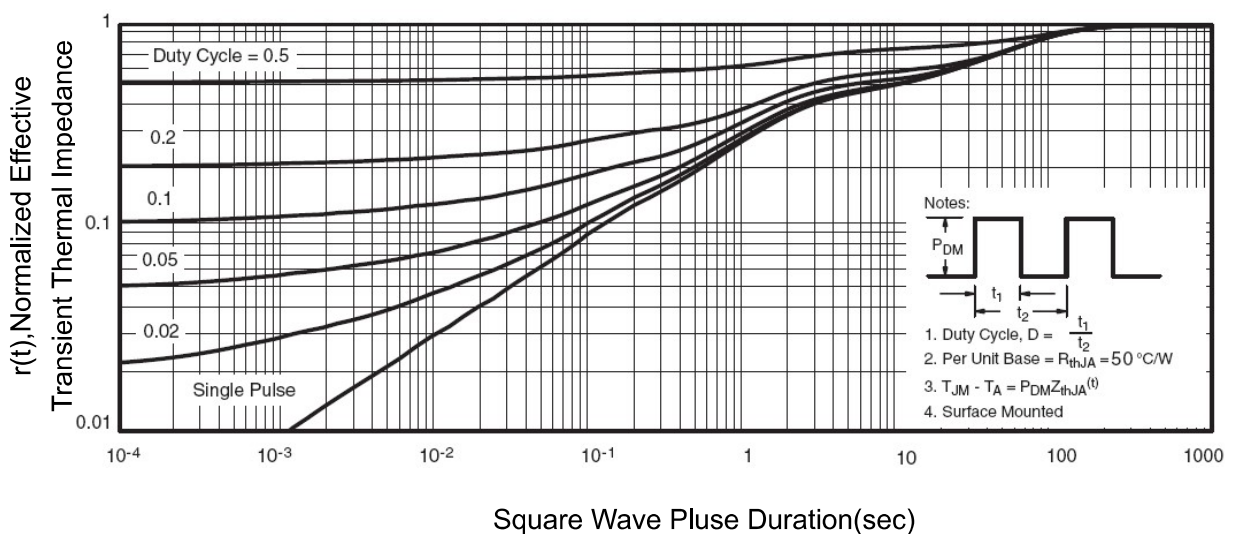
**Figure 8 BV<sub>DSS</sub> vs Junction Temperature**



**Figure 9 Safe Operation Area**

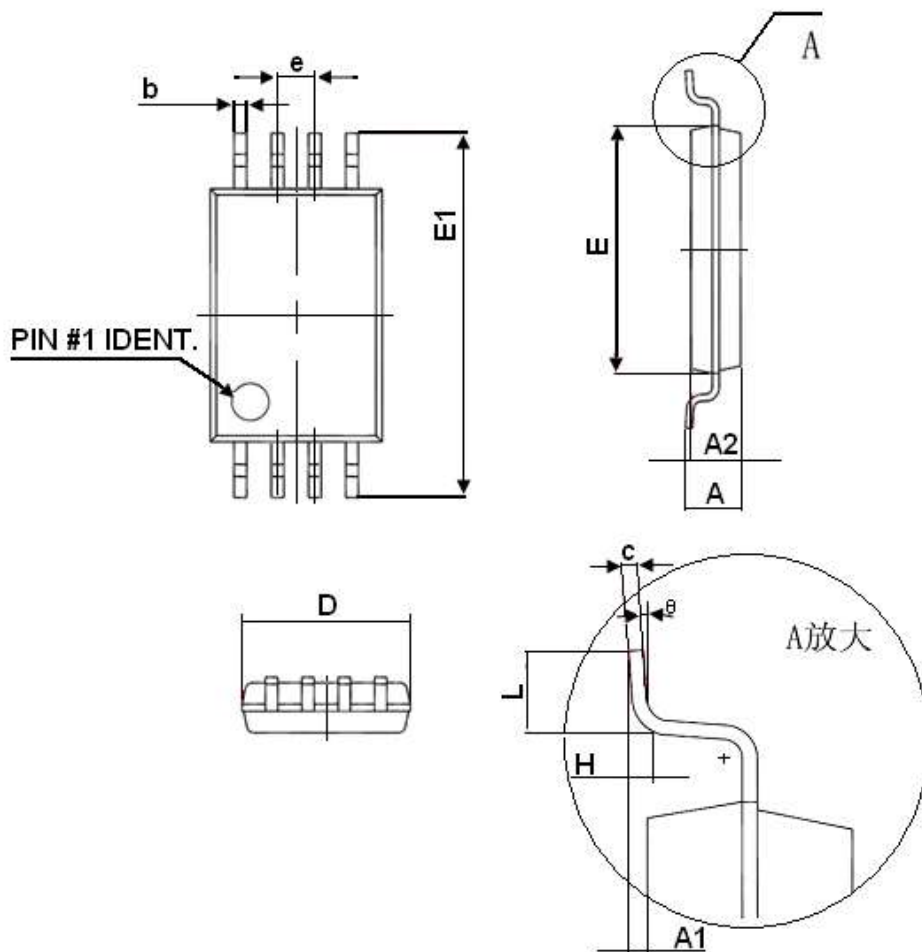


**Figure 10 Current vs Junction Temperature**



**Figure 11 Normalized Maximum Transient Thermal Impedance**

**TSSOP-8 PACKAGE INFORMATION**



Symbol	Dimensions In Millimeters	
	Min	Max
D	2.900	3.100
E	4.300	4.500
b	0.190	0.300
c	0.090	0.200
E1	6.250	6.550
A		1.100
A2	0.800	1.000
A1	0.020	0.150
e	0.65(BSC)	
L	0.500	0.700
H	0.25(TYP)	
$\theta$	1°	7°